

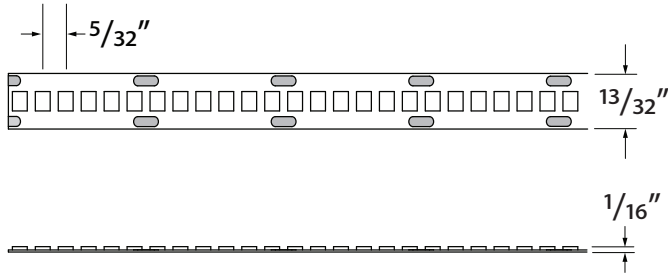

**Profile Dimensions**



**Please verify the contents of the packages!**

**Please read instructions entirely before starting installation**  
**Be sure power is turned off before installing or modifying the system**

**Call Tivoli, LLC tech support with questions**

**Caution:** Tivotape™ LED is designed to work with listed Class 2, 24V DC transformers only. Use of any other power source will cause damage, shorten the life of the fixture and will void the warranty.

**Consult** any and all applicable local and national codes for installation.

**Do not** conceal or extend exposed conductors through a building wall as per local electrical code.

**Warning:** With any luminaire for any application, basic safety precautions should always be followed to reduce the risk of fire, electric shock and personal injuries. This lighting system should be installed by a certified professional.



**Installation Instructions**

**CAUTION - Risk of Damage.** Handle carefully.

1. **Do not** twist, bend, fold or crease Tivotape™.
2. **Do not** bend or crease lead wire at solder point.
3. **Do not** attempt to remove Tivotape™ once it has been installed. Attempting to pull Tivotape™ away from mounting surface after it has been adhered will cause damage to the product.
4. **Do not** use chemical solvents on Tivotape™ during routine maintenance.
5. **Do not** exceed maximum linear run length of 13 feet.

**Failure to comply will damage the product and void the warranty.**

**Option 1: Direct to Surface**

**Note:** Use in clean, smooth, surface applications. Attaching to textured surfaces without the use of a mounting channel is not recommended.

**Step 1:** Identify Tivotape™ from supplied lengths to fit the area as marked.

**Step 2:** Tivotape™ is shipped with Lead Wire attached. To fit mounting location, Trim off excess Tivotape™ length from trail end at cutoff zones only.

Field cuttable section

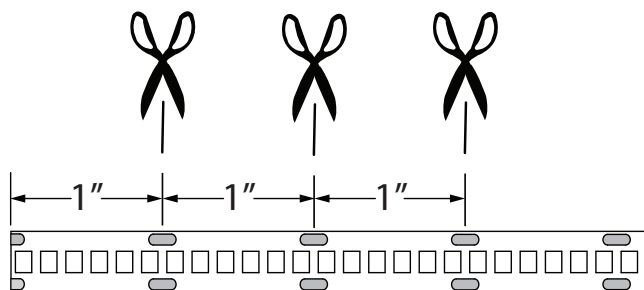

**Step 3:** Make sure surface where Tivotape™ is to be installed is smooth, clean, free of dirt, oil and debris.

**Note:** For backing tape to remain permanently attached, mounting surface must be clean and free of oil and debris.

**Caution:** Do not attempt to remove Tivotape™ once it has been adhered to surface. Stick down only once to avoid damage to the product. If there is a misapplication, remove the Tivotape™, clean off all adhesive from the mounting surface and start over with a new strip of Tivotape™ on a clean surface.

**Step 4:** Peel off 3M VHB tape backing and apply Tivotape™ to clean, smooth, surface area.

**Step 5:** Press firmly with hand along the entire length of Tivotape™ to ensure a strong bond to the mounting surface.

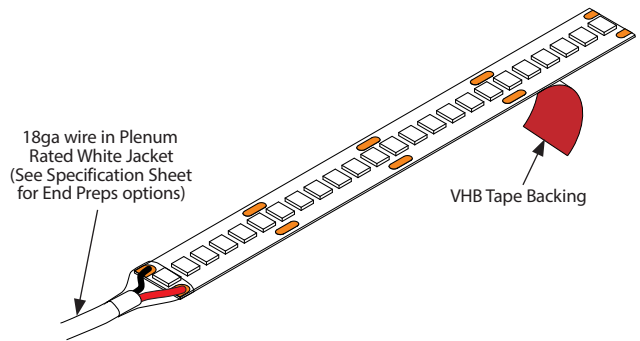

**Caution:** Do not bend, twist or crimp the lead wire at the solder connection point. This will damage the product and void the warranty.

**Step 6:** Make necessary electrical connections. (See Page 2)

## Installation Instructions (Continued)

### Option 2: Mounting Channel

Mounting channels are recommended for most applications to create a smooth, flat adhesion surface and are also used for different effects.

**Step 1:** Measure and cut mounting channel from supplied lengths to fit full length of mounting surface and drill countersunk mounting holes every 24" along channel.

**Step 2:** Attach mounting channel using No. 6 Flat Head screws (supplied by others) appropriate for mounting surface, ie: wood screws for wood.

**Step 3:** Make sure channel where Tivotape™ is to be installed is smooth, clean, free of all dirt, oil and debris.

**Note:** Cleaning channel mounting surface with alcohol is recommended.

**Step 4:** Peel off VHB backing tape and apply Tivotape™ to clean mounting channel.

**Step 5:** Press firmly with hand along the entire length of Tivotape™ to ensure a strong bond to the Mounting Channel.

**Step 6:** Install Lens and End Caps as required for application.

**Step 7:** Make necessary electrical connections.

### Examples of Available Channels:

**MCHAN-8-LP**  
Clear Polycarbonate Mounting Channel

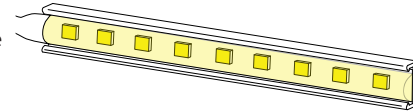

**TPL-45-MCH-8-S**  
45° Wide Mounting Channel

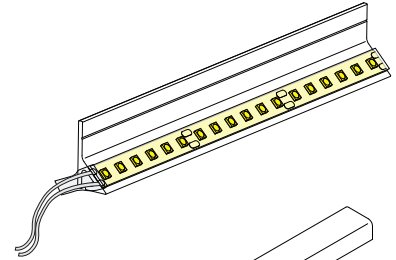

**INF-C-CHAN-8** Infinity Mounting Channel with lens for LED protection in tight spaces.

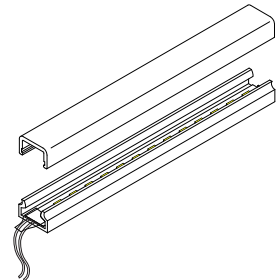

There are a variety of compatible Channels available in Plastic and Aluminum. See Specification Sheet for more information.

## Electrical Connections

**Step 1:** Turn power off before beginning electrical installation.

**Note:** Contacting hot wires against the Tivotape™ leads may damage the product and void the warranty.

**Step 2:** The Tivotape™ lead wires are marked for polarity. Connect to power source accordingly.

**Step 3:** Connect to a listed Class 2, 24V DC transformer only. See list of approved transformers.

**Step 4:** Tivotape may be dimmed using an MLV or ELV dimmer that is suitable for the power supply.

### Product Specification Guide

LIGHT SOURCE	MAX CONTINUOUS RUN LENGTH*
All color temperatures	13 ft

\*Max continuous run based on ADUL 96W/4.0A Power Supply max load. (Refer to Tivotape™ Specification Sheets for max run using other recommended power supplies.)

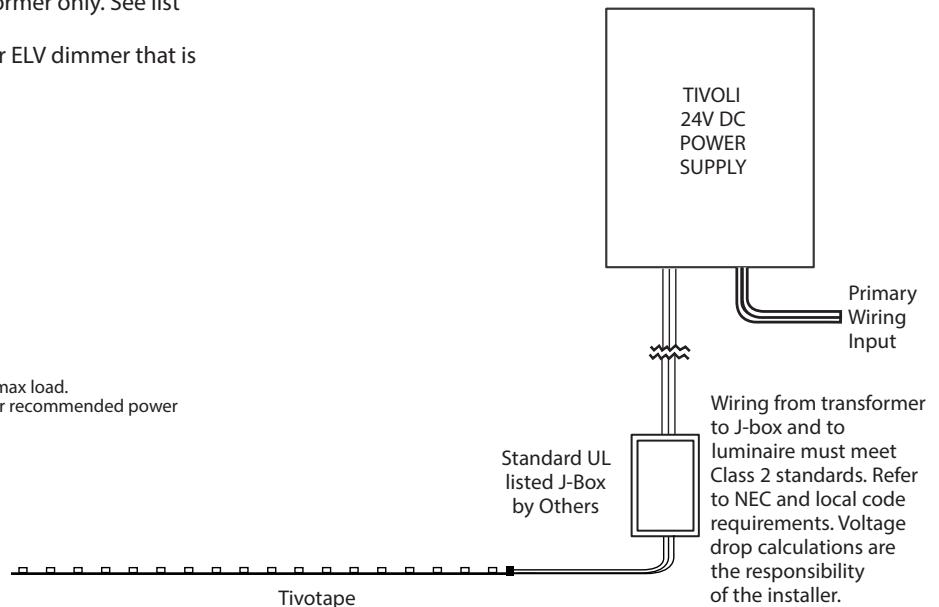

**Power Supply with 0-10V Sample Wiring Diagram**

There are many possible options for dimming Tivotape™. See the specification Sheet for more information. The following wiring diagram is for reference only. Please refer to the Installation Instruction for the Power Supply you choose for detailed wiring instructions.

