

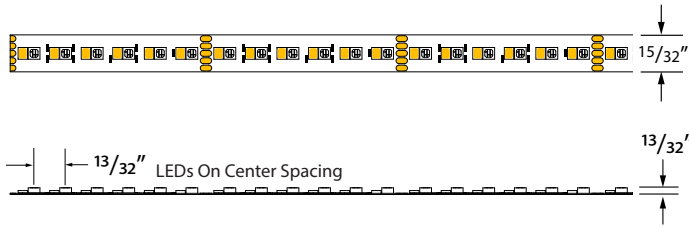

Profile Dimensions



Please verify the contents of the packages!

Please read instructions entirely before starting installation
Be sure power is turned off before installing or modifying the system

Call Tivoli, LLC tech support with questions

Caution: Tivotape™ LED is designed to work with listed Class 2 24V DC transformers only. Use of any other power source will cause damage, shorten the life of the fixture and will void the warranty.

Consult any and all applicable local and national codes for installation.

Do not conceal or extend exposed conductors through a building wall as per local electrical code.

Warning: With any luminaire for any application, basic safety precautions should always be followed to reduce the risk of fire, electric shock and personal injuries. This lighting system should be installed by a certified professional.



Installation Instructions

CAUTION - Risk of Damage. Handle carefully.

- Do not** twist, bend, fold or crease Tivotape™.
- Do not** bend or crease lead wire at solder point.
- Do not** attempt to remove Tivotape™ once it has been installed. Attempting to pull Tivotape™ away from mounting surface after it has been adhered will cause damage to the product.
- Do not** use chemical solvents on Tivotape™ during routine maintenance.

Failure to comply will damage the product and void the warranty.

Caution: Do not attempt to remove Tivotape™ once it has been adhered to surface. Stick down once to avoid damage to the product. If there is a misapplication, remove the Tivotape™, clean off all adhesive from the mounting surface and start over with a new strip of Tivotape™ on a clean surface.

Step 4: Peel off 3M VHB tape backing and apply Tivotape™ to clean, smooth, surface area.

Step 5: Press firmly with hand along the entire length of Tivotape™ to ensure a strong bond to the mounting surface.

Option 1: Direct to Surface

Note: Use in clean, smooth, surface applications. Attaching to textured surfaces without the use of a mounting channel is not recommended.

Step 1: Identify Tivotape™ from supplied lengths to fit the area as marked.

Step 2: Trim off excess length at cutoff zones only.

Field cuttable section

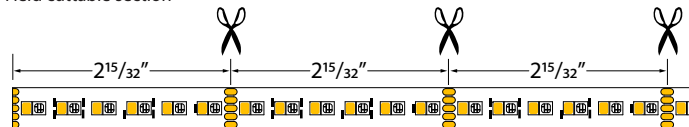

Step 3: Make sure surface where Tivotape™ is to be installed is smooth, clean, free of dirt, oil and debris.

Note: For backing tape to remain permanently attached, mounting surface must be clean and free of oil and debris.

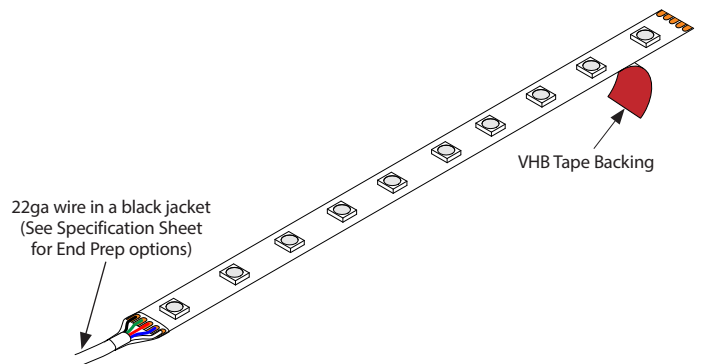

Caution: Do not bend, twist or crimp the lead wire at the solder connection point. This will damage the product and void the warranty.

Step 6: Make necessary electrical connections. (See Page 3)

Installation Instructions (Continued)

Option 2: Mounting Channel

Mounting channels are recommended for most applications to create a smooth, flat adhesion surface and are also used for different effects.

Step 1: Measure and cut mounting channel from supplied lengths to fit full length of mounting surface and drill countersunk mounting holes every 24" along channel.

Step 2: Attach mounting channel using No. 6 flat head screws (supplied by others) appropriate for mounting surface, ie: wood screws for wood.

Step 3: Make sure channel where Tivotape™ is to be installed is smooth, clean, free of all dirt, oil and debris. **Note:** Cleaning channel mounting surface with alcohol is recommended.

Step 4: Peel off VHB backing tape and apply Tivotape™ to clean mounting channel.

Step 5: Press firmly with hand along the entire length of Tivotape™ to ensure a strong bond to the Mounting Channel.

Step 6: Install Lens and End Caps as required for application.

Step 7: Make necessary electrical connections.

Examples of available Channels

MCHAN-8-LP
Clear Polycarbonate
Mounting Channel

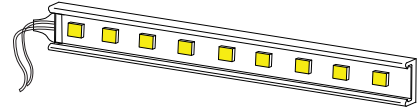

TPL-45-MCH-8-S
45° Wide Mounting Channel

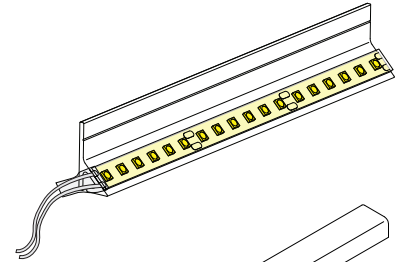

INF-C-CHAN-8 Infinity Mounting Channel
for LED protection in tight spaces

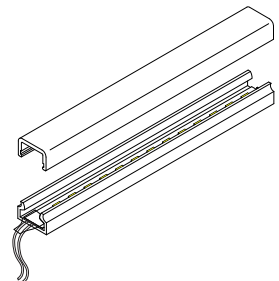

There are a variety of compatible Channels available in Plastic and Aluminum. See Specification Sheet for more information.

Maintaining Color Consistency

Note 1: Each RGBW LED is a composite of red, green and blue components. If the Tivotape light strip is located within 2" of an adjacent surface, the color closest to that surface may dominate the other colors. A distance of 2" or more will allow the light to even out and permit the colors to mix together.

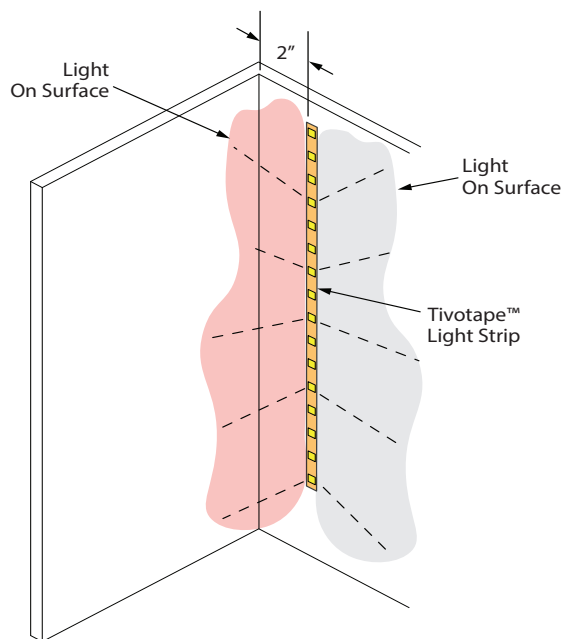

Note 2: In applications where multiple strips of Tivotape™ are reflecting on a common surface, it is recommended that the tape be mounted at least 2" away from the reflecting surface and oriented with the same edge of Tivotape™ mounted closest to the outside edge, as shown. Note the position of the lead end.

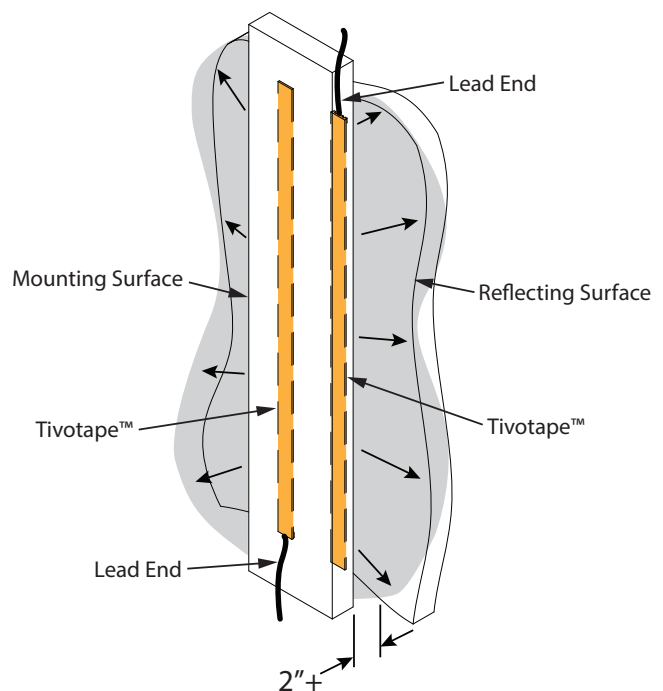

Tivotape™ RGBW Basic Wiring Diagram

Electrical Connections for Indoor RGBW Tivotape™

Step 1: Turn power off before beginning electrical installation.
Note: Contacting hot wires against the Tivotape™ leads may damage the product and void the warranty.
Step 2: Connect Tivotape™ lead wires to RGBW-Sub-Controller, or if using our ADUL-DIN series transformers, connect to pre-wired connectors which are found inside the power supply box. Refer to diagram on page 4. Make sure each lead wire is connected to the correct terminal, as follows:

TIVOTAPE™ PAD DESIGNATION	LEAD WIRE COLOR	SUB-CONTROLLER TERMINAL OR ADUL-DIN CONNECTOR WIRE COLOR
+	Black	Black (+)
G	Green	Green
R	Red	Red
B	Blue	Blue
W	White	White

Step 3: Connect to a listed Class 2, 24V DC transformer only. See list of approved transformers.
Step 4: Optionally, RGBW Tivotape™ may be dimmed using an MLV or ELV dimmer that is suitable for the power supply. Please contact our technical support staff for more information.

Product Specification Guide

LIGHT SOURCE	MAX CONTINUOUS RUN LENGTH*
All color temperatures	17ft

*Max continuous run based on ADUL 96W/4.0A Power Supply max load. (Refer to Tivotape™ Specification Sheets for max run using other recommended power supplies.)

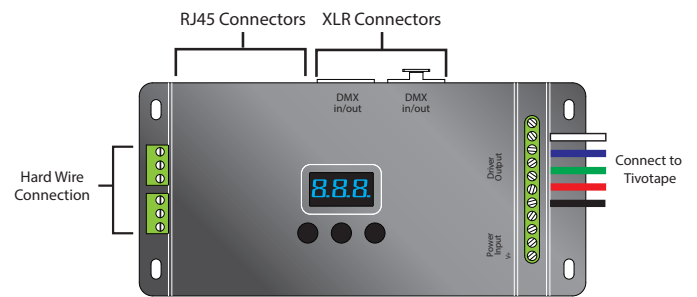

- DMX512 RDM decoder, RDM function can provide the interface between DMX master and decoder. for example, DMX decoder's address may be set from DMX master console.
- Multiple kinds of DMX in/out ports: RJ 45, XLR , normal screws.
- Total 5 PWM output channels, common anode. DMX channel quantity from 1CH~5CH programmable
- PWM output resolution ratio 8bit , 16bit settable.
- Output PWM frequency from 500HZ ~ 9K HZ settable.
- Output dimming curve gamma value from 0.1 ~ 9.9 settable.
- Programmable Decoding mode.

Safety and Warnings:

- Do not install with power applied to device.
- Do not expose to moisture.

Note: The Installation Instructions for your power supply includes DMX programming instructions.

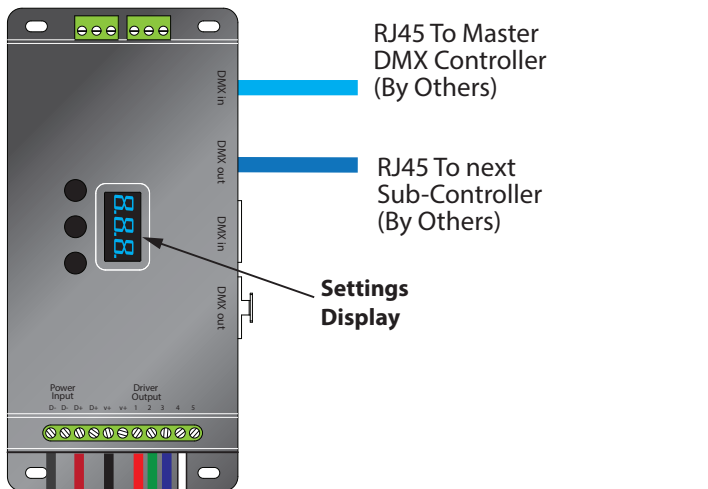
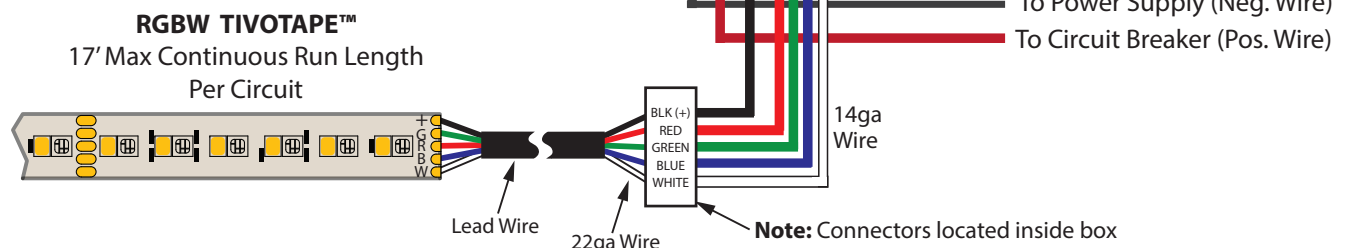

Power Supply with Sub-Controller Sample Wiring Diagram

There are many possible options for controlling RGBW Tivotape™. See the specification Sheet for more information. The following wiring diagram is for reference only. Please refer to the Installation Instruction for the Power Supply you choose for detailed wiring instructions.

