

**Profile Dimensions**

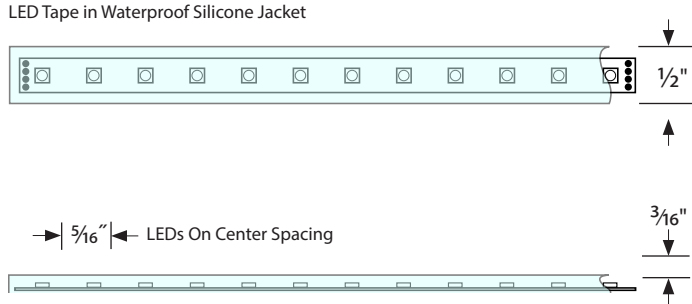

**Please verify the contents of the packages!**

**Please read instructions entirely before starting installation**

**Be sure power is turned off before installing or modifying the system**

**Call Tivoli, LLC tech support with questions**

**Caution:** Tivotape™ LED is designed to work with listed Class 2 24V DC transformers only. Use of any other power source will cause damage, shorten the life of the fixture and will void the warranty.

**Consult** any and all applicable local and national codes for installation.

**Do not** conceal or extend exposed conductors through a building wall as per local electrical code.

**Warning:** With any luminaire for any application, basic safety precautions should always be followed to reduce the risk of fire, electric shock and personal injuries. This lighting system should be installed by a certified professional.

**Installation Instructions**



**CAUTION - Risk of Damage.** Handle carefully.

1. **Do not** twist, bend, fold or crease Tivotape™.
2. **Do not** bend or crease lead wire at solder point.
3. **Do not** attempt to remove Tivotape™ once it has been installed. Attempting to pull Tivotape™ away from mounting surface after it has been adhered will cause damage to the product.
4. **Do not** use chemical solvents on Tivotape™ during routine maintenance.

**Failure to comply will damage the product and void the warranty.**

**Option 1: Direct to Surface**

**Note:** Use in clean, smooth, surface applications. Attaching to textured surfaces without the use of a mounting channel is not recommended.

**Step 1:** Identify Tivotape™ from supplied lengths to fit the area as marked.

**Note:** Outdoor Tivotape™ is shipped manufactured to specific lengths with factory attached end preps. It is not designed to be trimmed in the field.

**Step 2:** Make sure surface where Tivotape™ is to be installed is smooth, clean, free of dirt, oil and debris.

**Note:** For backing tape to remain permanently attached, mounting surface must be clean and free of oil and debris.

**Caution:** Do not attempt to remove Tivotape™ once it has been adhered to surface. Stick down once to avoid damage to the product. If there is a misapplication, remove the Tivotape™, clean off all adhesive from the mounting surface and start over with a new strip of Tivotape™ on a clean surface.

**Step 3:** Peel off PET tape backing and apply Tivotape™ to clean, smooth surface area.

**Step 4:** Press firmly with hand along the entire length of Tivotape™ to ensure a strong bond to the mounting surface.

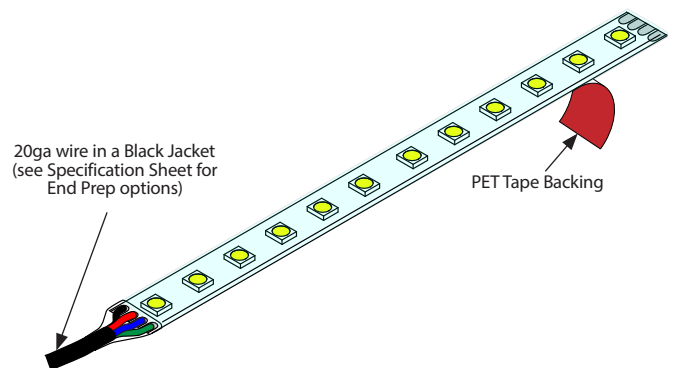

**Caution:** Do not bend, twist or crimp the lead wire at the solder connection point. This will damage the product and void the warranty.

**Step 5:** Make necessary electrical connections. (See Page 3)

## Installation Instructions (Continued)

### Option 2: Mounting Channel

Mounting channels are recommended for most applications to create smooth, flat adhesion surface and are used for different effects.

**Step 1:** Measure and cut mounting channel from supplied lengths to fit full length of mounting surface and drill countersunk mounting holes every 24" along channel.

**Step 2:** Attach mounting channel using No. 6 flat head screws (supplied by others) appropriate for mounting surface, ie: wood screws for wood.

**Step 3:** Make sure channel where Tivotape™ is to be installed is smooth, clean, free of all dirt, oil and debris.

**Note:** Cleaning channel mounting surface with alcohol is recommended.

**Step 4:** Peel off PET backing tape and apply Tivotape™ to clean mounting channel.

**Step 5:** Press firmly with hand along the entire length of Tivotape™ to ensure a strong bond to the Mounting Channel.

**Step 6:** Install Lens and End Caps as required for application.

**Step 7:** Make necessary electrical connections.

### Examples of Available Channels

**MCHAN-8-LP**  
Clear Polycarbonate Mounting Channel

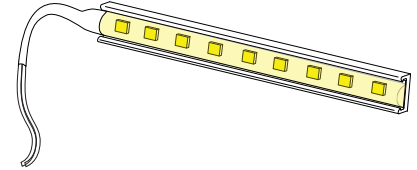

**MRSL-CHAN-SLV-6.5**  
Marsala Mounting Channel, shown with Lens and Mounting Clips

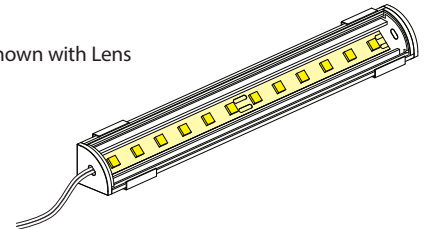

There are a variety of compatible Channels available in Plastic and Aluminum. See Specification Sheet for more information.

## Connecting Tivotape Outdoor Variable Sections Using Outdoor Butt Connectors



**Step 3:** Use Heat Gun to heat Butt Connector. Continue to heat until Butt Connector shrinks to a tight seal around both wire ends. This will ensure a water-tight connection.

To connect two sections of Tivotape™ in the field, use outdoor rated Butt Connectors. A Ratchet Crimping Tool and Heat Gun is required.

**Step 1:** Strip ¼" of Insulation from the end of each wire and insert one end of each wire into Butt Connector.

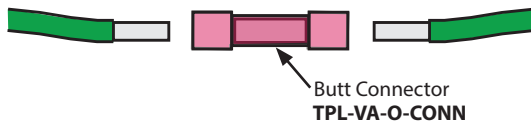

**Step 2:** Use Ratchet Crimping Tool to securely crimp each wire inside the Butt Connector in the areas shown.

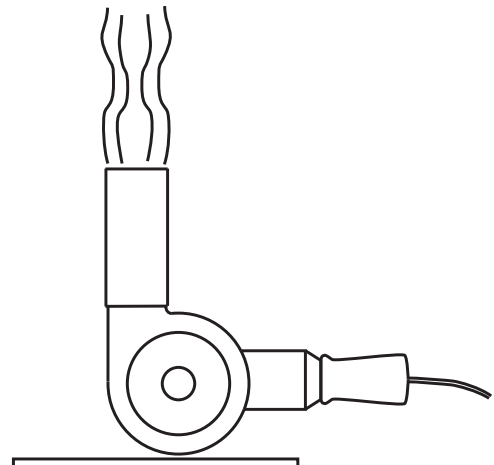
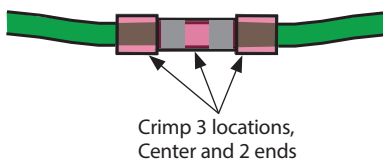

## Tivotape™ Variable Outdoor Wiring Diagram for 5 Channel DMX Digital Controller

### Electrical Connections for Variable Outdoor Tivotape™

**Step 1:** Turn power off before beginning electrical installation.

**Note:** Contacting hot wires against the Tivotape™ leads may damage the product and void the warranty.

**Step 2:** Connect Tivotape™ lead wires to RGBW-Sub-Controller, or if using our ADN-M-VW series transformers, connect to pre-wired terminal blocks which are found inside the power supply box. Refer to diagram on page 4. Make sure each lead wire is connected to the correct terminal, as follows:

TIVOTAPE™ PAD DESIGNATION	LEAD WIRE COLOR	SUB-CONTROLLER TERMINAL OR ADN-M-DIN CONNECTOR WIRE COLOR
+	Black	Black (+)
-	Red	Red
+	Blue	Black (+)
-	Green	Green

**Step 3:** Connect to a listed Class 2, 24V DC transformer only. See list of approved transformers.

**Step 4:** Optionally, Variable Tivotape™ may be dimmed using an MLV or ELV dimmer that is suitable for the power supply. Please contact our technical support staff for more information.

### Product Specification Guide

LIGHT SOURCE	MAX CONTINUOUS RUN LENGTH*
All color temperatures	32ft

\*Max continuous run based on ADUL 96W/4.0A Power Supply max load. (Refer to Tivotape™ Specification Sheets for max run using other recommended power supplies.)

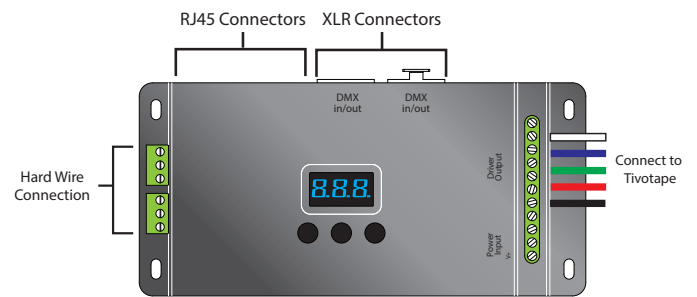

### Basic Sub-Controller

DESCRIPTION	CAT NO	MODES	OUTPUT POWER	PRIMARY VOLTAGE	DIMENSION
DMX Subcontroller	TPL-RGBW-180-24	Subcontroller only	5X(96-192)W	24V DC	2.85" W X 6.45" L X 1.5" H

- DMX512 RDM decoder, RDM function can provide the interface between DMX master and decoder. for example, DMX decoder's address may be set from DMX master console.
- Multiple kinds of DMX in/out ports: RJ 45, XLR, normal screws.
- Total 5 PWM output channels, common anode. DMX channel quantity from 1CH~5CH programmable
- PWM output resolution ratio 8bit, 16bit settable.
- Output PWM frequency from 500HZ ~ 9K HZ settable.
- Output dimming curve gamma value from 0.1 ~ 9.9 settable.
- Programmable Decoding mode.

### Safety and Warnings:

- Do not install with power applied to device.
- Do not expose to moisture.

**Note:** The Installation Instructions for your power supply includes DMX programming instructions.

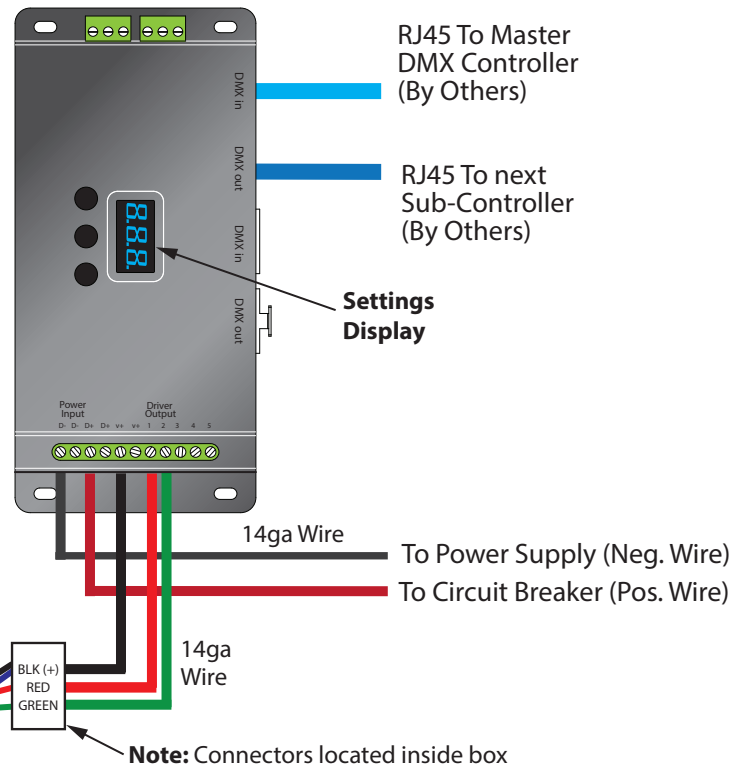

### TIVOTAPE™ VARIABLE OUTDOOR 32' Max Continuous Run Length Per Circuit

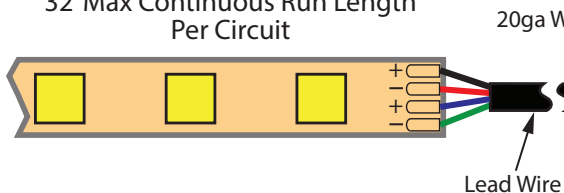

**Note:** Connectors located inside box

### Power Supply with Sub-Controller Sample Wiring Diagram

There are many possible options for controlling Variable Tivotape™. See the specification Sheet for more information. The following wiring diagram is for reference only. Please refer to the Installation Instruction for the Power Supply you choose for detailed wiring instructions.

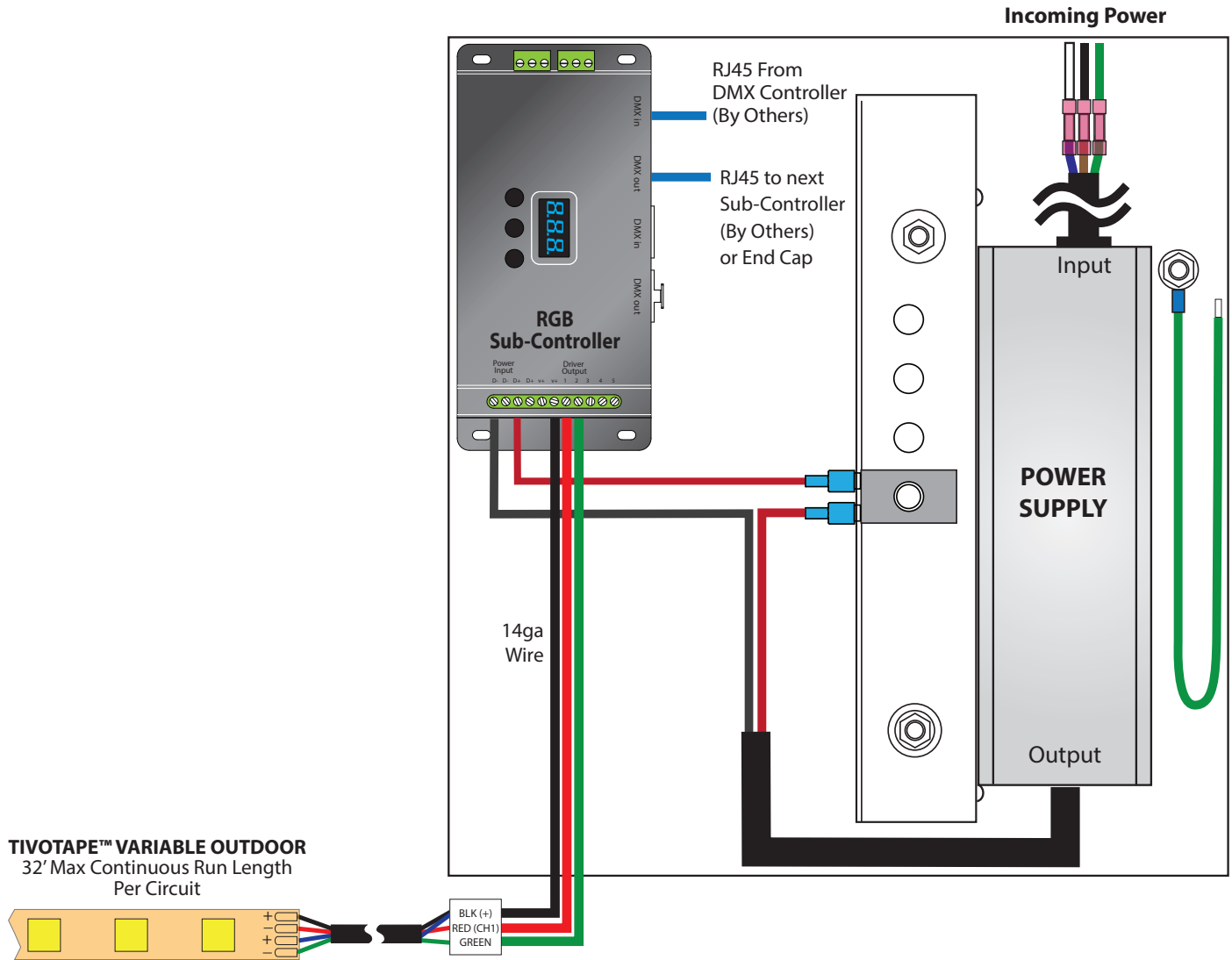

## Tivotape™ Variable Outdoor Wiring Diagram for 3 Channel Decoder

### Install Transformer Enclosure

**Step 1:** Locate Transformer enclosure in a suitable indoor or outdoor location. Power supply enclosure is water-tight and may be installed in outdoor wet environments.

**Step 2:** Connect Transformer input to 120-277V AC line voltage.

**Step 3:** Connect each luminaire linear run to one on the 3 circuit connectors. Installer is responsible to select the right size wire for run length and total wattage for each circuit. Do not exceed 90 watts per circuit.

TIVOTAPE™ PAD DESIGNATION	LEAD WIRE COLOR	SUB-CONTROLLER TERMINAL OR ADM-DIN CONNECTOR WIRE COLOR
+	Black	Black (+)
-	Red	Red
+	Blue	Black (+)
-	Green	Green

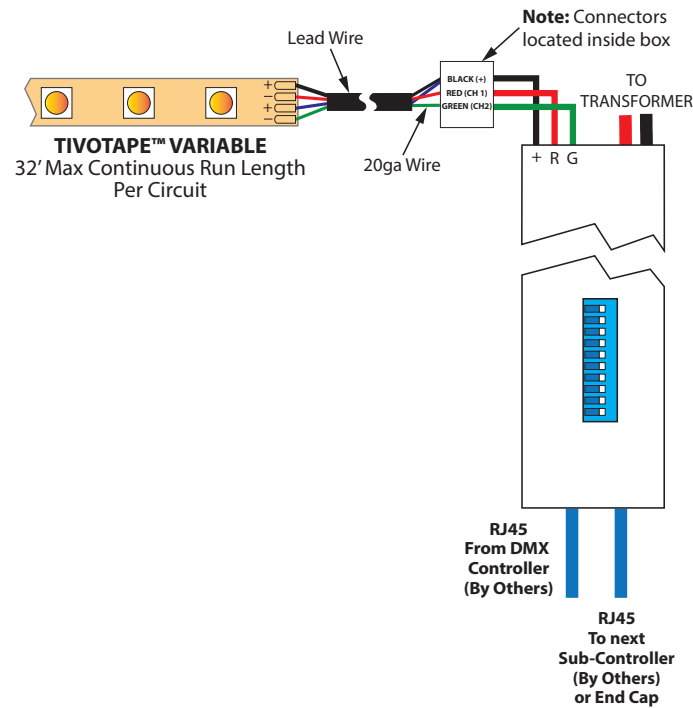

### Connect RGB Controller to Sub-Controller

**Step 1:** Interconnect RGB controller (DMX512 signal) to Sub-Controller using CAT5 Cable with RJ45 connectors. Refer to the diagram for custom wiring applications. Be sure to maintain correct polarity if custom wiring is required.

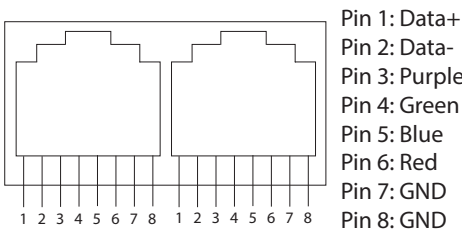

### DMX-512 Address Code Setting

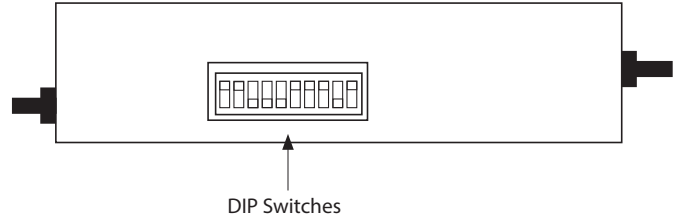

This sub-controller has a total of 512 address codes. 1 represents the least significant byte (LSB) and 9 is most significant byte (MSB). The initial address code is the DMX signal received by Channel 1 of the decoder. Channel 2 will receive data on the initial address code + 1 and Channel 3 will receive data on the initial address code + 2. The initial address code is the sum of DIP switches 1-9 in the “On” position. The 10th switch is not used.

Move a switch up to turn it on and leave it in the down position to achieve a “0” value.

### Value of each DIP Switch

DIP	1	2	3	4	5	6	7	8	9
VALUE	1	2	4	8	16	32	64	128	256

Example: Set to 38

Set the 2nd, 3rd and 6th switch to “1” and set the rest to “0”. The sum of the switches is 2+4+32 for an address of 38.

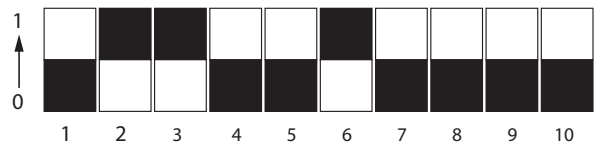

### Basic Programming Codes:

- RED: 1 off, 2 through 9 on
- BLUE: 1 and 2 off, 3 through 9 on
- GREEN: 2 off, 1 and 3 through 9 on
- WHITE: 3 off, 1, 2 and 4 through 9 on
- DMX SIGNAL: 1 on, 2 through 9 off

Power Supply Wiring Diagram with 3 Channel DMX Sub-Controller

**TIVOTAPE™ VARIABLE**  
32' Max Continuous Run Length

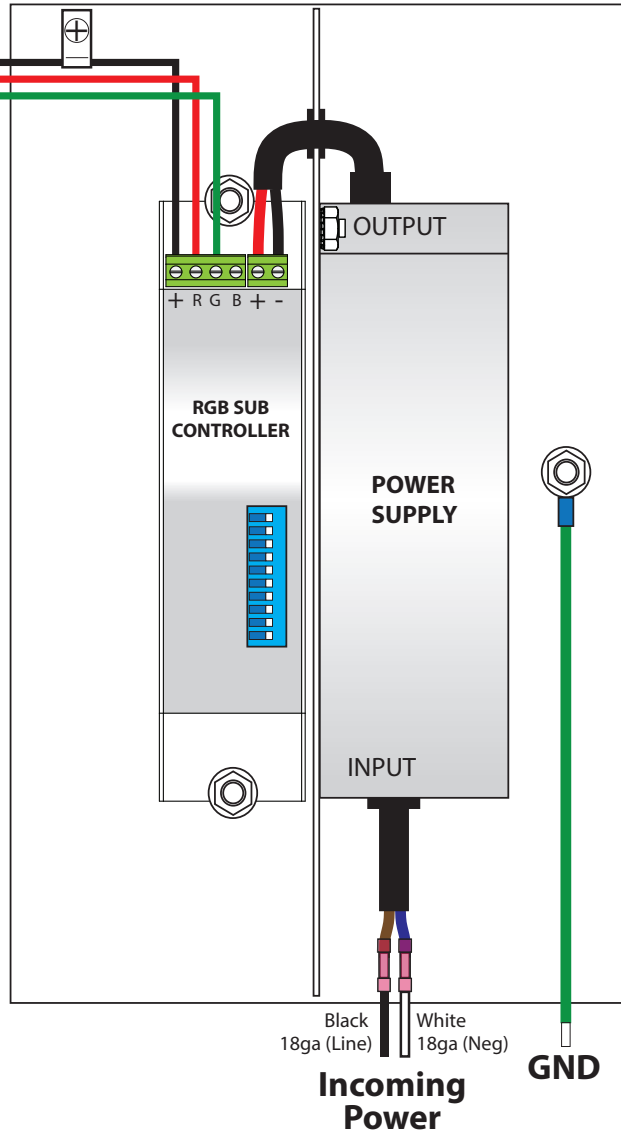

**ADNM-90-1-4-24-VW**  
**Outdoor (NEMA 3 Rated)**

90W / 1 Circuit X 4A

Box Size: 6.00"W X 8.25"L X 4.50"D