

Profile Dimensions

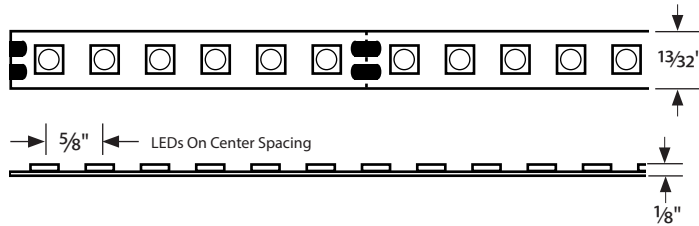

Please verify the contents of the packages!

Please read instructions entirely before starting installation

Be sure power is turned off before installing or modifying the system

Call Tivoli, LLC tech support with questions

Caution: Tivotape™ LED is designed to work with listed Class 2, 24V DC transformers only. Use of any other power source will cause damage, shorten the life of the fixture and will void the warranty.

Consult any and all applicable local and national codes for installation.

Do not conceal or extend exposed conductors through a building wall as per local electrical code.

Warning: With any luminaire for any application, basic safety precautions should always be followed to reduce the risk of fire, electric shock and personal injuries. This lighting system should be installed by a certified professional.



Installation Instructions

CAUTION - Risk of Damage. Handle carefully.

1. **Do not** twist, bend, fold or crease Tivotape™.
2. **Do not** attempt to remove Tivotape™ once it has been installed. Attempting to pull Tivotape™ away from mounting surface after it has been adhered will cause damage to the product.
4. **Do not** use chemical solvents on Tivotape™ during routine maintenance.

Failure to comply will damage the product and void the warranty.

Option 1: Direct to Surface

Note: Use in clean, smooth, surface applications. Attaching to textured surfaces without the use of a mounting channel is not recommended.

Step 1: Unwind Tivotape™ from roll and cut to length according to project layout.

Step 2: Trim off excess length at cutoff zones only.

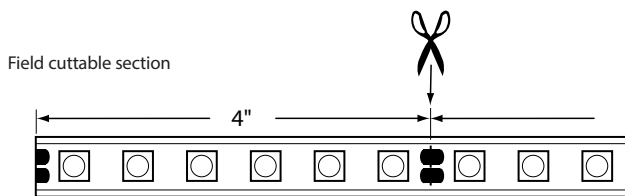

Step 3: Make sure surface where Tivotape™ is to be installed is smooth, clean, free of dirt, oil and debris.

Note: For backing tape to remain permanently attached, mounting surface must be clean and free of oil and debris.

Caution: Do not attempt to remove Tivotape™ once it has been adhered to surface. Stick down once to avoid damage to the product. If there is a misapplication, remove the Tivotape™, clean off all adhesive from the mounting surface and start over with a new strip of Tivotape™ on a clean surface.

Make Connections Using Tivotape™ Connectors

Use the included Connectors to connect Tivotape™ to power source and to interconnect segments of Tivotape™

Step 4: Locate the Wire Lead and pull open the locking face, as shown.

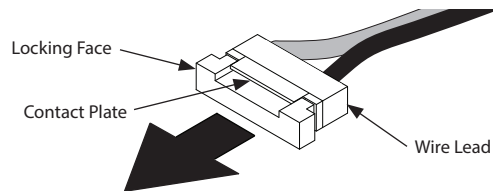

Step 5: IMPORTANT! Use a small utility knife to scrape the eXoShield™ coating from each of the Pads and peel away the 3M VHB backing tape just from the end of the Tivotape™.

WARNING! Risk of product failure.

The eXoShield™ coating must be scraped away from the contact pads in order to create a solid electrical connection.

Step 6: Connect a Wire Lead to the Lead End of the run.

Caution: Orient the Connector so the small white Contact Plate at the opening of the Connector is facing up.

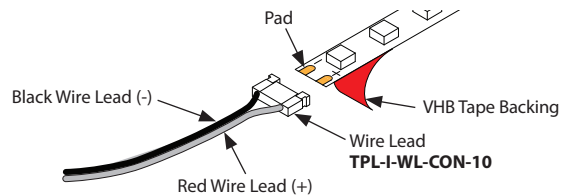

Step 7: Press the Locking Face all the way in to lock the Connector onto the Tivotape™.

Step 8: Continue to peel away the backing tape as the Tivotape™ is applied to a clean, smooth, surface area.

Step 9: Press firmly with hand along the entire length of Tivotape™ to ensure a strong bond to the mounting surface.

Step 10: Connect additional segments of Tivotape™ using supplied connectors. It is recommended that all connectors are attached to Tivotape™ before applying it to surface as described in Steps 5 through 8.

Step 11: Make electrical connections.

Installation Instructions (Continued)

Option 2: Mounting Channel

Mounting channels are recommended for most applications to create a smooth, flat adhesion surface and also to create different visual effects. Some styles of Channel may require a different Installation method than described below. Consult factory for details.

Step 1: Measure and cut mounting channel from supplied lengths to fit full length of mounting surface and drill countersunk mounting holes every 24" along channel.

Step 2: Attach mounting channel using No. 6 Flat Head screws (supplied by others) appropriate for mounting surface, ie: wood screws for wood.

Step 3: Make sure channel surface where Tivotape™ is to be installed is smooth, clean, free of all dirt, oil and debris. **Note:** Cleaning the channel mounting surface with alcohol is recommended.

Make Connections Using Tivotape™ Connectors

Use the included Connectors to connect Tivotape™ to power source and to interconnect segments of Tivotape™

Step 4: Locate the Wire Lead and pull open the locking face, as shown.

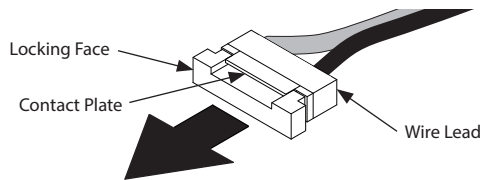

Note: Ten each of five Connector options are included with your Tivotape™ order.

Warning: Do not exceed the maximum linear run length per circuit. Max run lengths vary based on power Supply. See page 3 for details.

Step 5: IMPORTANT! Use a small utility knife to scrape the eXoShield™ coating from each of the Pads and peel away the 3M VHB backing tape just from the end of the Tivotape™.

WARNING! Risk of product failure.

The eXoShield™ coating must be scraped away from the contact pads in order to create a solid electrical connection.

Step 6: Connect a Wire Lead to the Lead End of the run.

Caution: Orient the Connector so the small white Contact Plate at the opening of the Connector is facing up.

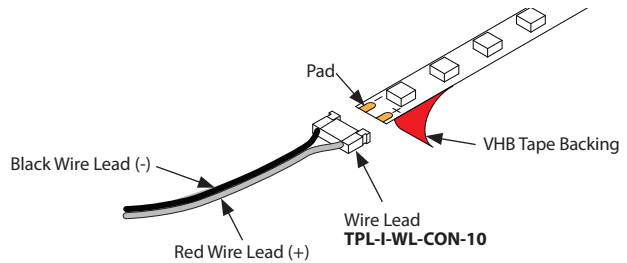

Step 6: Press the Locking Face all the way in to lock the Connector onto the Tivotape™.

Step 7: Continue to peel away the backing tape as the Tivotape™ is applied to a clean, smooth channel surface.

Step 8: Install Lens and End Caps as required for application.

Step 9: Connect additional segments of Tivotape™ using supplied connectors. It is recommended that all connectors are attached to Tivotape™ before applying it to surface as described in Steps 5 through Step 7.

Step 10: Make electrical connections.

Note: Use the included connector options to run Tivotape™ around corners and to join multiple segments of Tivotape™ together.

Power Leads and Jumper Connectors

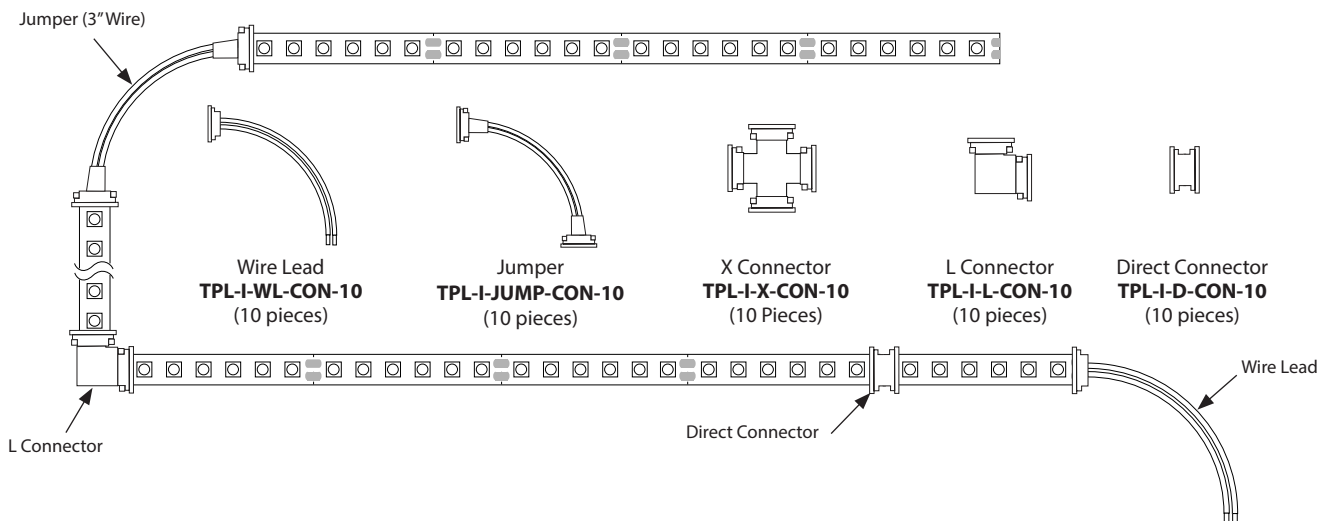

Compatible Channels

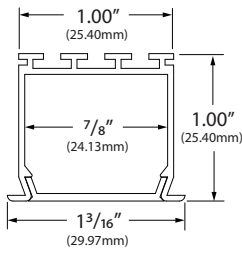

LOKM-CHAN-6.5*
Anodized Channel with flush lens, clips into **TKUS** channel (optional) available in 6.5' lengths

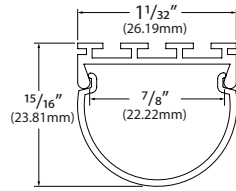

DOM-CHAN-SLV-6.5*
Anodized Aluminum Extrusion, available in 6.5' lengths.

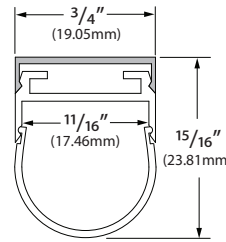

TPL-AL-CHAN-1A-8*
AL Series Aluminum Channel with Mounting Carrier Base. Available in 8 ft standard lengths.

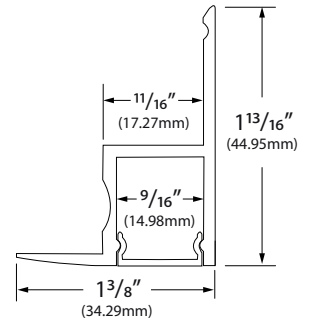

EDGE-CHAN-WHT-6.5 (WHITE)*
EDGE-CHAN-SLV-6.5 (SLIVER)*
Aluminum Ceiling Edge Lit Channel with flush frosted lens (included), Finish options in white and silver, available in 6.5' lengths.

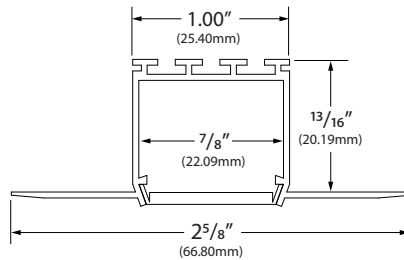

KOZL-CHAN-6.5*
Aluminum channel with flush lens, available in 6.5' length

*Lenses and End Caps available separately. Refer to Tivotape™ specification sheets for details.

Electrical Connections

Electrical Connections

- Step 1:** Turn power off before beginning electrical installation.
- Note:** Contacting hot wires against the Tivotape™ leads may damage the product and void the warranty.
- Step 2:** The Tivotape™ lead wires are marked for polarity. Connect to power source accordingly.
- Step 3:** Connect to a listed Class 2, 24V DC transformer only. See list of approved transformers.
- Step 4:** Tivotape may be dimmed using an MLV or ELV dimmer that is suitable for the power supply.

Product Specification Guide

LIGHT SOURCE	MAX CONTINUOUS RUN LENGTH*
All color temperatures	21 ft

*Max continuous run based on ADUL 96W/4.0A Power Supply max load. (Refer to Tivotape™ Specification Sheets for max run using other recommended power supplies.)

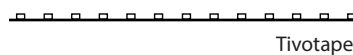
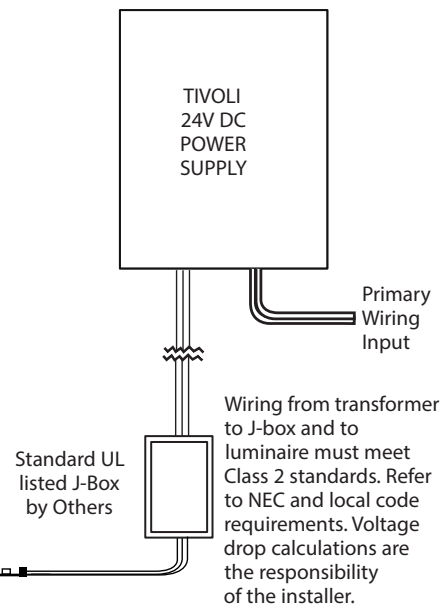

Power Supply with 0-10V Sample Wiring Diagram

There are many possible options for dimming TivoTape™. See the specification Sheet for more information. The following wiring diagram is for reference only. Please refer to the Installation Instruction for the Power Supply you choose for detailed wiring instructions.

