



Project: \_\_\_\_\_ Type: \_\_\_\_\_

- Optically clear polycarbonate co-extruded directional lens features 65° lighting cut-off for hidden, discreet illumination.
- Base and lens available in 8' field cuttable lengths with optional row indicator window.
- End-to-end continuous mounting with continuous 18AWG, 2 conductor through wires minimize voltage drop.
- Use with Tivoli's patented two-tone bullnose stair nosing with reflective edge.

Dimensions



Single Illumination System

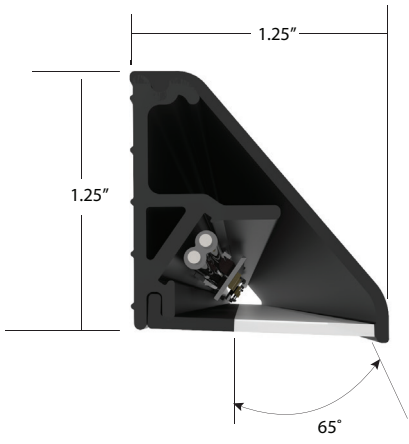

Optional Row Indicator Window

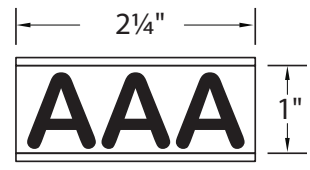



Order Guide

PRODUCT CODE: **FWTT**  
**FWTT** = Fantasma Wall Titanium

PCB SPACING: **06** = 6"  
**12** = 12"  
**16** = 16"

LED: **19** = 1900K  
**27** = 2700K  
**30** = 3000K  
**35** = 3500K  
**40** = 4000K  
**AM** = Amber  
**RD** = Red  
**BL** = Blue

FINISH: **M**  
**M** = Matte

FIXTURE LENGTH: **8.0**  
**8.0** = 8'

Specification

**6" Spacing (based on 3000K)**

Kelvin Temperature	1900K	2700K	3000K	3500K	4000K	Red	Blue	Amber
Lumens/ft	CF	CF	38	CF	CF	N/A	N/A	N/A
Efficacy (Lm/W)	CF	CF	35	CF	CF	N/A	N/A	N/A
CRI	CF	CF	83	CF	CF	N/A	N/A	N/A
Listed Power W/ft.	1.10					1.54	1.16	0.55
Max Run	33'					40'	28'	28

**12" Spacing (based on 3000K)**

Kelvin Temperature	1900K	2700K	3000K	3500K	4000K	Red	Blue	Amber
Lumens/ft	CF	CF	19	CF	CF	N/A	N/A	N/A
Efficacy (Lm/W)	CF	CF	35	CF	CF	N/A	N/A	N/A
CRI	CF	CF	83	CF	CF	N/A	N/A	N/A
Listed Power W/ft.	0.55					0.77	0.58	0.63
Max Run	65'					80'	55'	55'

**16" Spacing (based on 3000K)**

Kelvin Temperature	1900K	2700K	3000K	3500K	4000K	Red	Blue	Amber
Lumens/ft	CF	CF	14.25	CF	CF	N/A	N/A	N/A
Efficacy (Lm/W)	CF	CF	CF	CF	CF	N/A	N/A	N/A
CRI	CF	CF	CF	CF	CF	N/A	N/A	N/A
Listed Power W/ft.	0.4125					0.58	0.39	0.473
Max Run	86'					106'	73'	73'

Electrical	
Input Voltage	12V
Dimming	MLV/ELV/0-10V/DMX
Certification and Testing	
Certification	cETLus, ADA, NFPA
Lumen Maintenance (L70)	75,000 hrs
Environment	Dry & Damp Location
Warranty	5 years

Replacement Part

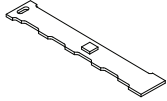

**FTT-LED-XX**  
**XX=19** (1900K), **27** (2700K), **30** (3000K), **40** (4000K), **AM** (Amber), **BL** (Blue), **RD** (Red)  
 Replacement PCB

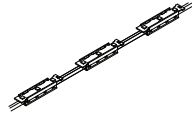

**FTT-XX-STRAND-XX**  
**XX = 06** (6"), **12** (12"), **16** (16")  
**XX=9** (1900K), **27** (2700K), **30** (3000K), **35** (3500K), **40** (4000K), **AM** (Amber), **BL** (Blue), **RD** (Red)  
 Replacement Strand  
 With 6", 12", 16" O.C.PCB spacing  
 Sold per ft. - Indicate at time of ordering

**FTT-RI-19**  
**XX=19** (1900K), **27** (2700K), **30** (3000K), **35** (3500K), **40** (4000K), **AM** (Amber), **BL** (Blue), **RD** (Red)  
 ROW INDICATOR LED



**FTT-WINDOW**  
 Replacement Window Only  
 Snaps easily into position along installed base and interconnects with outer lens cover for seamless profile.

In-Wall Controls



Touchscreen

**TVOQ-1-WH**  
 White



Touchscreen

**TVOQ-10-XX-7**  
**XX = BK** (Black), **WH** (White)



Touchscreen

**TVOQ-2-BK**  
 Black

Mounting Accessories



**FWTT-EC2-X**  
X = L (Left), R (Right)  
Fantasma End Cap

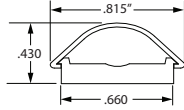

**BS-CC-8**  
Wall Wireway, 8' black base &  
conduit cover

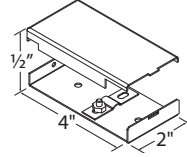

**JBOX-LP**  
Junction box, low profile



**BSL-PC-1/4**  
1/4" Flex Conduit, Black

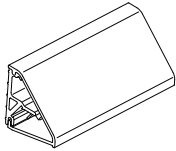

**FWTT-LENS-M-8**  
Fantasma lens - 8'  
**WLS-BASE-8**  
Wall light system base - 8'

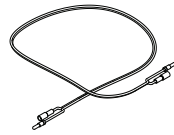

**TT-JUMPER-2**  
24 inch lead wire



**TM-2-3/8**  
Self tapping wall screw, Phillips  
profile - 2 3/8" length

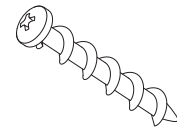

**TM-1-1/2**  
Self tapping, deep cutting,  
corkscrew-like thread,  
Phillips profile - 1 1/2" length

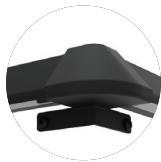

**FWTT-O-CRNR**  
Outside corner joint,  
matte black



**FWTT-I-CRNR**  
Inside corner joint,  
matte black



**FWTT-U-JNT**  
Upward wall joint,  
matte black

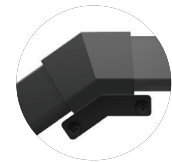

**FWTT-D-JNT**  
Downward wall joint,  
matte black



**FWTT-ST-JNT**  
Straight joint,  
matte black

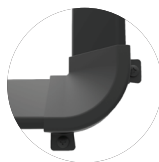

**FWTT-OV-CRNR**  
90° Outside  
vertical Joint,  
matte black



**FWTT-IV-CRNR**  
90° Inside  
vertical Joint,  
matte black

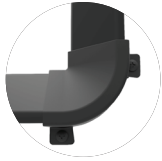

90° Vertical Outside



90° Vertical Inside

**90° Vertical Inside and Outside Joints**

Engineered for new theater formats that include reclining seats; these new brackets enable full cut off glare. The vertical part of the assembly over the stairs acts as a wire way to the Titanium LEDs installed on the horizontal portion over each step to achieve the full cut off of glare. This new method follows the stair lines versus the hand rail lines of the 35° joint.

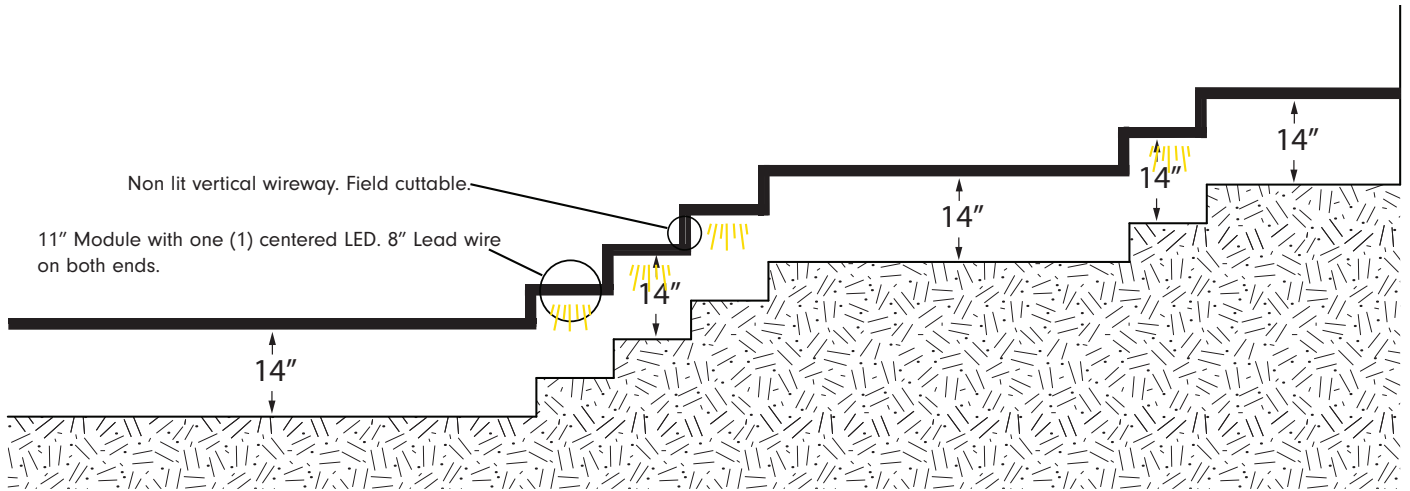

35° Up



35° Down

**35° Joints**

Engineered for 35° downward mounting angles over the stairs, in theaters, where standard seating and landing spacing are utilized. This method may not fully eliminate glare as with the 90° joints and installation method.

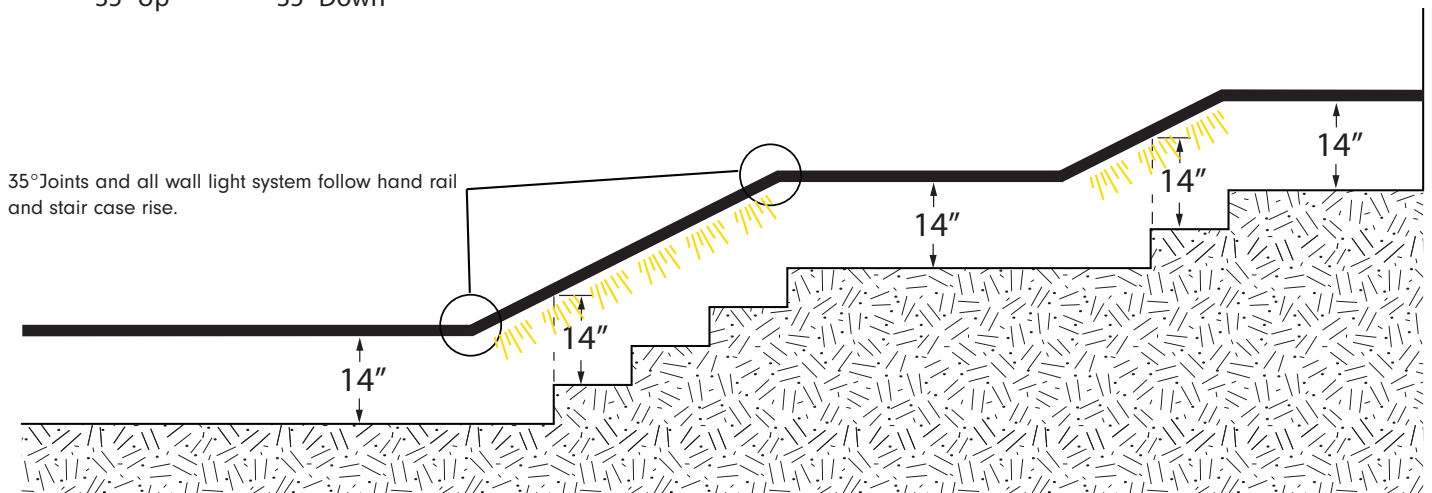



Power Supplies

**ADUL - NON DIMMING**

DESCRIPTION	CAT NO	APPLICATION	PRIMARY VOLTAGE	SECONDARY VOLTAGE	CIRCUIT BREAKERS	MAX LOAD	CIRCUIT CAPACITY
ADUL Series Class 2 Transformer	ADUL-80-1-5-12-D	Indoor / Damp	100-277V AC 50/60 HZ	12V DC	1	60W	5A
	ADUL-150-2-5-12-D				2	2x60W	2x5A
	ADUL-240-3-5-12-D				3	3x60W	3x5A
	ADUL-320-4-5-12-D				4	4x60W	4x5A

**ADUL - 0-10V DIMMING**

DESCRIPTION	CAT NO	APPLICATION	PRIMARY VOLTAGE	SECONDARY VOLTAGE	CIRCUIT BREAKERS	MAX LOAD	CIRCUIT CAPACITY
ADUL Series Class 2 Transformer	ADUL-80-1-5-12-DOT	Indoor / Damp	100-277V AC 50/60 HZ	12V DC	1	60W	5A
	ADUL-150-2-5-12-DOT				2	2x60W	2x5A
	ADUL-240-3-5-12-DOT				3	3x60W	3x5A
	ADUL-320-4-5-12-DOT				4	4x60W	4x5A

**ADUL - DMX SINGLE ADDRESS**

DESCRIPTION	CAT NO	APPLICATION	PRIMARY VOLTAGE	SECONDARY VOLTAGE	CIRCUIT BREAKERS	MAX LOAD	CIRCUIT CAPACITY
ADUL Series Class 2 Transformer	ADUL-80-1-5-12-DIN	Indoor / Damp	100-277V AC 50/60 HZ	12V DC	1	60W	5A
	ADUL-150-2-5-12-DIN				2	2x60W	2x5A
	ADUL-240-3-5-12-DIN				3	3x60W	3x5A

**ADUL - DMX MULTI ADDRESS**

DESCRIPTION	CAT NO	APPLICATION	PRIMARY VOLTAGE	SECONDARY VOLTAGE	CIRCUIT BREAKERS	MAX LOAD	CIRCUIT CAPACITY
ADUL Series Class 2 Transformer	ADUL-150-2-5-12-DIN-2	Indoor / Damp	100-277V AC 50/60 HZ	12V DC	2	2x60W	2x5A
	ADUL-240-3-5-12-DIN-3				3	3x60W	3x5A
	ADUL-320-4-5-12-DIN-4				4	4x60W	4x5A

**INFINITY - MLV / ELV / 0-10V / PWM / TRIAC**

DESCRIPTION	CAT NO	APPLICATION	PRIMARY VOLTAGE	SECONDARY VOLTAGE	CIRCUIT BREAKERS	MAX LOAD	MIN LOAD	CIRCUIT CAPACITY
Infinity Series Class 2 Transformer	INF-J-30-1-2.5-12	Indoor / Outdoor	100 - 277V AC	12V DC	1	30W	3W	2.5A
	INF-J-60-1-5-12				1	60W	6W	5A
	INF-J-180-3-5-12				3	3x60W	3x6W	3x5A
	INF-J-300-5-5-12				5	5x60W	5x6W	5x5A



Dimmers

**DIMMING - 0-10V**

DESCRIPTION	CAT NO	APPLICATION	INPUT VOLTAGE	OUTPUT VOLTAGE	MAX LOAD
0-10V Dimmer	DIM-LD-010	Indoor	12V/24V DC	12V/24V DC	30 mA max. output (sink only)

**DIMMING - MLV**

DESCRIPTION	CAT NO	APPLICATION	INPUT VOLTAGE	OUTPUT VOLTAGE	MAX LOAD
MLV Dimmer	N-600	Indoor	120V AC	120V AC	450W
	N-1000				800W
	N-1500				1200W
	D-600				450W
	M-600				450W
	M-1000				800W

**DIMMING - ELV**

DESCRIPTION	CAT NO	APPLICATION	INPUT VOLTAGE	OUTPUT VOLTAGE	MAX LOAD
ELV Dimmer	ME-600	Indoor	120V AC	120V AC	450W
	DE-300				300W

TwoTone Bullnose & Accessories

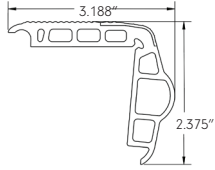

**BNS-XXX-GY-12**  
**XXX = TT** (black/gray), **TT2** (black/2"gray), **SC** (solid gray)  
 TwoTone Bullnose, 12' length

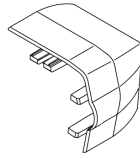

**BNS-TT-EC-X**  
**X = L** (left side), **R** (right side)  
 Bullnose Overlap End Caps, black

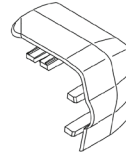

**BNS-CC-TT-EC-X**  
**X = L** (left side), **R** (right side)  
 Bullnose Carpet to Carpet End Caps, black

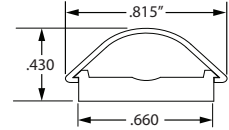

**BS-CC-8**  
 Wall Wireway, 8' black base & conduit cover

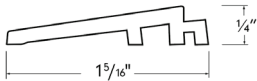

**BNS-TT-R-12**  
 Step Reducer, 12' section

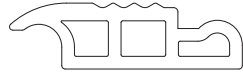

**STP-EXTNDR-12**  
 Bullnose Step Landing Tread Extender, 12'



**ADH-MB-75AM-XX**  
**XX = 10** (10.1 oz tubes, 30 per case.), **29** (29 oz tubes 12 per case)



**ADH-IA-10.2-CA**  
 End cap clear liquid adhesive, 10.2 oz tubes sold individually, 12 per case

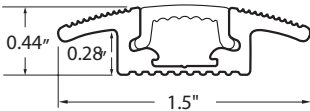

**WW-XX-XX-8**  
**XX = CC** (Carpet to Carpet base ), **CW** (Carpet to Wall base)  
**XX = BK** (black lense), **GY** (gray lense)  
 Base and Cover Combo, 8' length

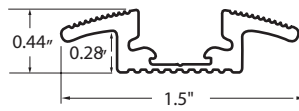

**WW-XX-BS-8**  
**XX = CC** (Carpet to Carpet), **CW** (Carpet to Wall)  
 Base Only, black, 8' length

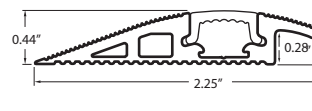

**WW-CE-XX-8**  
**XX = BK** (black), **GY** (gray)  
 Carpet to Edge Base and Cover Combo, 8' length

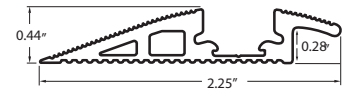

**WW-CE-BS-8**  
 Base Only, Carpet To Edge, black, 8' length



**WW-TC-XX-8**  
**XX = BK** (Black), **GY** (Gray), **CL** (Clear), **BZ** (Bronze)  
 Top Cover Wire Way lens, 8' length



**RONDB-5/32**  
 Concrete Drill Bit 5/32"

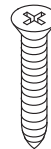

**TM-3/16**  
 Concrete Screw 3/16" x 1 3/4"