

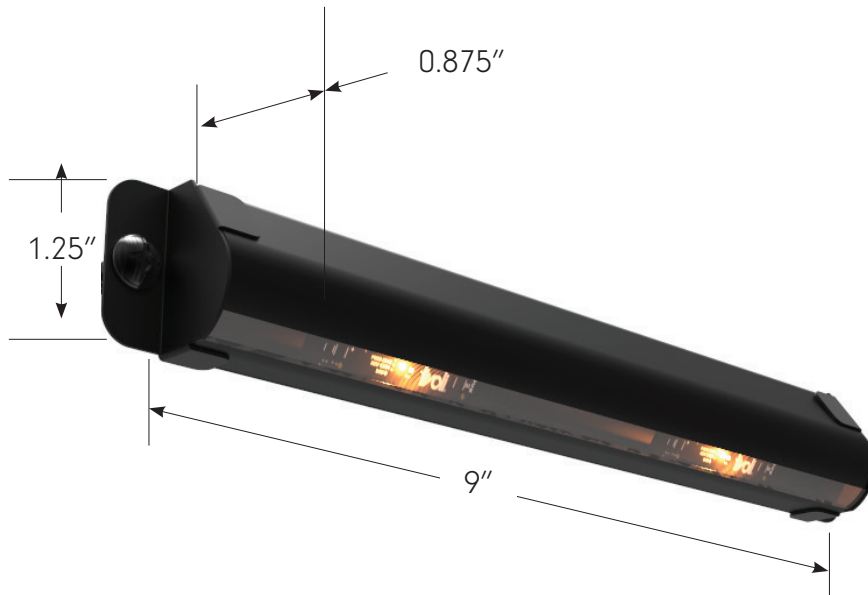

Project: \_\_\_\_\_ Type: \_\_\_\_\_

- Compact size 9" x 1.25" x 0.875" hidden light source, tamper resistant seat mounted LED lighting system.
- Individually replaceable LED PCBs easily snap into Titanium modules for easy and economical maintenance.
- 48" super-flex conduit standard for wireway connection.
- Use with Tivoli's patented two-tone bullnose stair nosing and wireway with reflective edge to step delineation to maximize voltage drop.

## Dimensions



## Ordering Guide

PRODUCT CODE	FEEDPOINT	LED BOTTOM	NUMBER OF LEDS	FINISH
<b>UST</b>				<b>M</b>
UST = Usher Seat Titanium	<b>C</b> = Center <b>R</b> = Right <b>L</b> = Left	<b>19</b> = 1900K <b>27</b> = 2700K <b>30</b> = 3000K <b>35</b> = 3500K <b>40</b> = 4000K <b>AM</b> = Amber <b>RD</b> = Red <b>BL</b> = Blue	<b>02</b> = Low Brightness <b>03</b> = Standard Brightness	M = Matte

## Specification

Electrical (based on 3000K Sample)		
LED Brightness	Low	Standard
*Lumens/ft	21	33
*Watts/unit	0.5	0.7
*Lumen/watt	47	
Beam Angle	45°	
CRI	>80/TYP83	
Kelvin Temp	1900K, 2700K, 3000K, 3500K, 4000K (+/- 80K) 3SDCM, Red, Blue, Amber	
Operating Voltage	12V DC	
Dimming	MLV	
Certification and Testing		
Certification	cETLus, ADA, NFPA	
Environment	Damp Location	
Power Supply	Class 2	
Rated Life	75,000 hrs.	
Warranty	5 years	

## Mounting Accessories

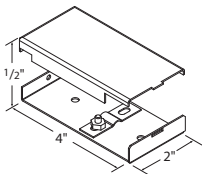

**JBOX-LP**  
Junction box, low profile

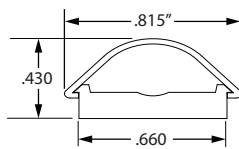

**BS-CC-8**  
Wall wireway, 8' Black Base & Conduit Cover



**BSL-PC-1/4**  
0.25" Flex Conduit, Black

Replacement Parts

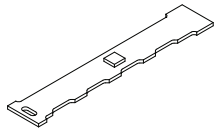

**UTT-LED-XX**  
**XX = 19** (1900K), **27** (2700K),  
**30** (3000K), **35** (3500K),  
**40** (4000K), **AM** (amber),  
**BL** (blue), **RD** (red)

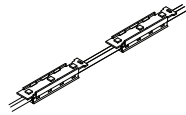

**UTT-02-STRAND-XX**  
**XX = 19** (1900K), **27** (2700K),  
**30** (3000K), **35** (3500K),  
**40** (4000K), **AM** (amber),  
**BL** (blue), **RD** (red)  
 2 Modules per foot replacement  
 strand with LEDs

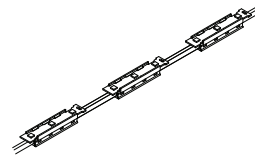

**UTT-03-STRAND-XX**  
**XX = 19** (1900K), **27** (2700K),  
**30** (3000K), **35** (3500K),  
**40** (4000K), **AM** (amber),  
**BL** (blue), **RD** (red)  
 3 Modules per foot replacement  
 strand with LEDs

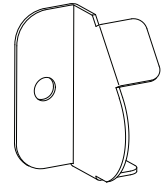

**UTT-EC-X**  
**X = L** (left), **R** (right)  
 End Cap

In-Wall Controls



**TVOQ-1-WH**  
 White



**TVOQ-10-XX-7**  
**XX = BK** (Black), **WH** (White)



**TVOQ-2-BK**  
 Black

Power Supplies

**ADNM - NON DIMMING**

DESCRIPTION	CAT NO	APPLICATION	PRIMARY VOLTAGE	SECONDARY VOLTAGE	CIRCUIT BREAKERS	MAX LOAD	CIRCUIT CAPACITY
ADNM Series Class 2 Transformer	ADNM-60-1-5-12-D	Indoor / Outdoor	100-277V AC 50/60 HZ	12V DC	1	60W	5A
	ADNM-80-1-5-12-D				1	60W	5A
	ADNM-150-2-5-12-D				2	2x60W	2x5A
	ADNM-240-3-5-12-D				3	3x60W	3x5A
	ADNM-320-4-5-12-D				4	4x60W	4x5A

**ADNM - 0-10V DIMMING**

DESCRIPTION	CAT NO	APPLICATION	PRIMARY VOLTAGE	SECONDARY VOLTAGE	CIRCUIT BREAKERS	MAX LOAD	CIRCUIT CAPACITY
ADNM Series Class 2 Transformer	ADNM-60-1-5-12-DOT	Indoor / Outdoor	100-277V AC 50/60 HZ	12V DC	1	60W	5A
	ADNM-80-1-5-12-DOT				1	60W	5A
	ADNM-150-2-5-12-DOT				2	2x60W	2x5A
	ADNM-240-3-5-12-DOT				3	3x60W	3x5A
	ADNM-320-4-5-12-DOT				4	4x60W	4x5A

**ADNM - DMX SINGLE ADDRESS**

DESCRIPTION	CAT NO	APPLICATION	PRIMARY VOLTAGE	SECONDARY VOLTAGE	CIRCUIT BREAKERS	MAX LOAD	CIRCUIT CAPACITY
ADNM Series Class 2 Transformer	ADNM-60-1-5-12-DIN	Indoor / Outdoor	100-277V AC 50/60 HZ	12V DC	1	60W	5A
	ADNM-80-1-5-12-DIN				1	60W	5A
	ADNM-150-2-5-12-DIN				2	2x60W	2x5A
	ADNM-240-3-5-12-DIN				3	3x60W	3x5A
	ADNM-320-4-5-12-DIN				4	4x60W	4x5A

**ADNM - DMX MULTI ADDRESS**

DESCRIPTION	CAT NO	APPLICATION	PRIMARY VOLTAGE	SECONDARY VOLTAGE	CIRCUIT BREAKERS	MAX LOAD	CIRCUIT CAPACITY
ADNM Series Class 2 Transformer	ADNM-150-2-5-12-DIN-2	Indoor / Damp	100-277V AC 50/60 Hz	12V DC	2	2x60W	5A
	ADNM-240-3-5-12-din-3				3	3x60W	3x5A

**INFINITY - MLV / ELV / 0-10V / TRIAC**

DESCRIPTION	CAT NO	APPLICATION	PRIMARY VOLTAGE	SECONDARY VOLTAGE	CIRCUIT BREAKERS	MAX LOAD	MIN LOAD	CIRCUIT CAPACITY
Infinity Series Class 2 Transformer	INF-J-30-1-2-5-12	Indoor / Outdoor	100 - 277V AC	12V DC	1	30W	3W	2.5A
	INF-J-60-1-5-12				1	60W	6W	5A
	INF-J-180-3-5-12				3	3x60W	3x6W	3x5A
	INF-J-300-5-5-12				5	5x60W	5x6W	5x5A



Dimmers

**DIMMING - 0-10V**

DESCRIPTION	CAT NO	APPLICATION	INPUT VOLTAGE	OUTPUT VOLTAGE	MAX LOAD
0-10V Dimmer	DIM-LD-010	Indoor	12V/24V DC	12V/24V DC	30 mA max. output (sink only)

**DIMMING - MLV**

DESCRIPTION	CAT NO	APPLICATION	INPUT VOLTAGE	OUTPUT VOLTAGE	MAX LOAD
MLV Dimmer	N-600	Indoor	120V AC	120V AC	450W
	N-1000				800W
	N-1500				1200W
	D-600				450W
	M-600				450W
	M-1000				800W

**DIMMING - ELV**

DESCRIPTION	CAT NO	APPLICATION	INPUT VOLTAGE	OUTPUT VOLTAGE	MAX LOAD
ELV Dimmer	ME-600	Indoor	120V AC	120V AC	450W
	DE-300				300W

TwoTone Bullnose & Accessories

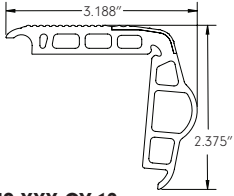

**BNS-XXX-GY-12**  
**XXX = TT** (black/gray), **TT2** (black/2"gray), **SC** (solid gray)  
 TwoTone Bullnose, 12' length

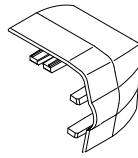

**BNS-TT-EC-X**  
**X = L** (left side), **R** (right side)  
 Bullnose Overlap End Caps, black

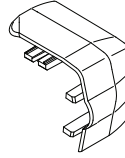

**BNS-CC-TT-EC-X**  
**X = L** (left side), **R** (right side)  
 Bullnose Carpet to Carpet End Caps, black

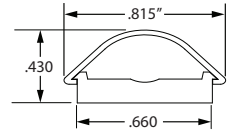

**BS-CC-8**  
 Wall Wireway, 8' black base & conduit cover

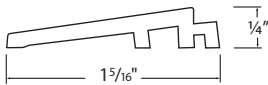

**BNS-TT-R-12**  
 Step Reducer, 12' section

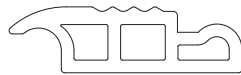

**STP-EXTNDR-12**  
 Bullnose Step Landing Tread Extender, 12'



**ADH-MB-75AM-XX**  
**XX = 10** (10.1 oz tubes, 30 per case), **29** (29 oz tubes 12 per case)



**ADH-IA-10.2-CA**  
 End cap clear liquid adhesive, 10.2 oz tubes sold individually, 12 per case

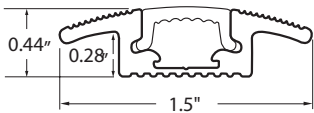

**WW-XX-XX-8**  
**XX = CC** (Carpet to Carpet base), **CW** (Carpet to Wall base)  
**XX = BK** (black lense), **GY** (gray lense)  
 Base and Cover Combo, 8' length

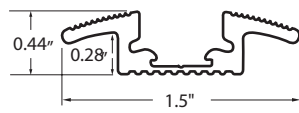

**WW-XX-BS-8**  
**XX = CC** (Carpet to Carpet), **CW** (Carpet to Wall)  
 Base Only, black, 8' length



**WW-TC-XX-8**  
**XX = CL** (clear) **BK** (black), **BZ** (bronze), **GY** (gray)  
 Top Cover Wire Way lens, 8' length

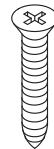

**TM-3/16**  
 Concrete Screw 3/16" x 1 3/4"

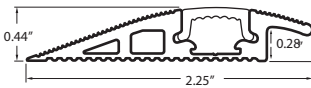

**WW-CE-XX-8**  
**XX = BK** (black), **GY** (gray)  
 Carpet to Edge Base and Cover Combo, 8' length



**WW-CE-BS-8**  
 Base Only, Carpet To Edge, black, 8' length



**RON-DB-5/32**  
 Concrete Drill Bit 5/32"