



tivoli

A simple, highly effective, affordable stage edge lighting solution.
"Because performer safety matters!"

STAGE EDGE
Angle Marker

StageEdge™ Layout Diagram

Note: Proper orientation of the Finish Tube (03) is necessary for correct power feed delivery. Please reference the diagram below for Stage Left or Stage Right orientation. In addition, At time of ordering, exact measurements of each left and right Finish Tube (03) are necessary to complete your ordered run and should be included with your notes. See page (4) for details.

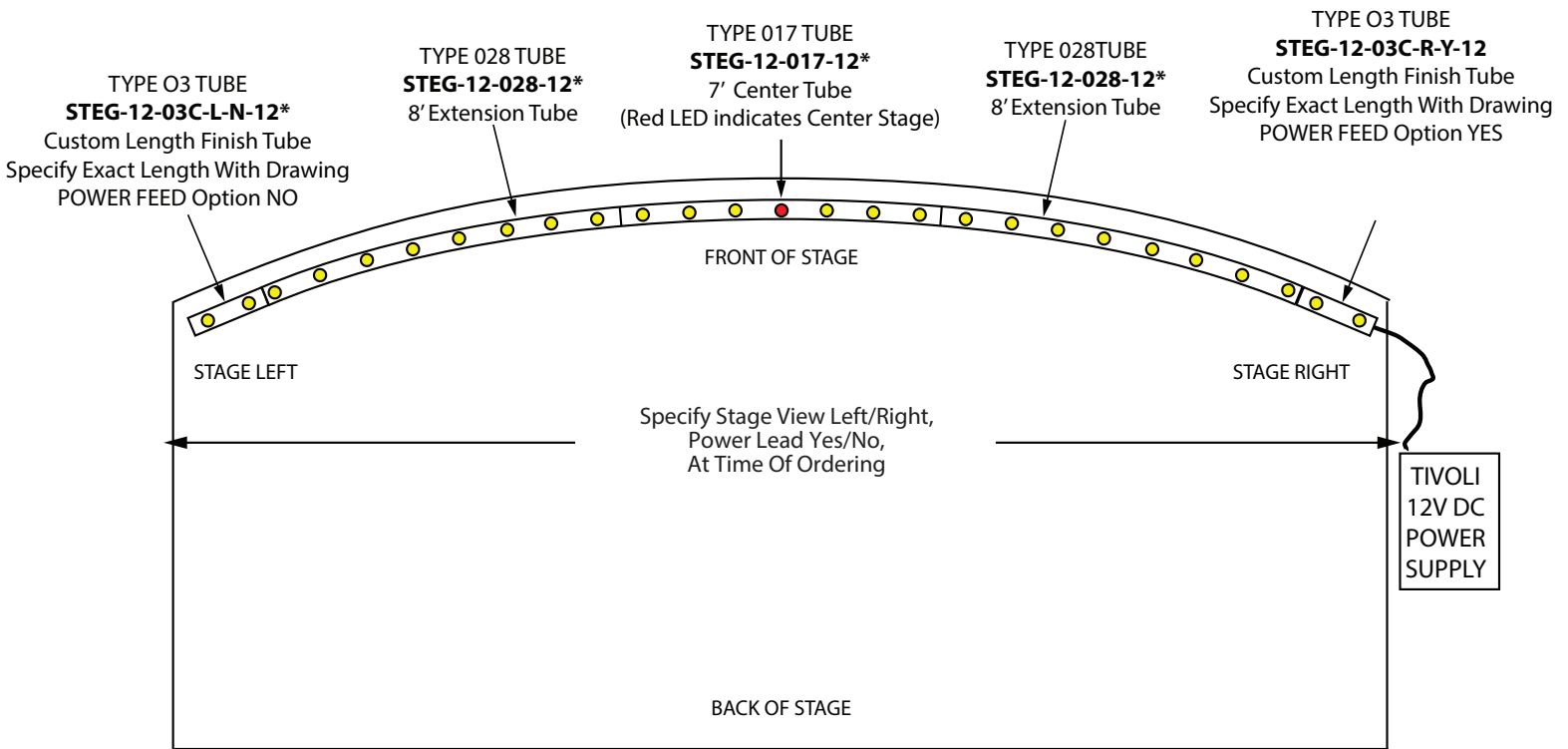

* Tube may be curved to a maximum radius of 20'.

StageEdge Angled Stage Marker is an LED assist light that creates marker indication for direct view from stage only.

Features

- For venue stage floors - recess flush mounted
- Designed to support the roll-over weight of a Grand Piano when flush mounted
- TT1010 rectangular (1/2" x 9/16") clear polycarbonate tubing in 3 sizes: Center, Extension and Finish
- Smooth full range dimming capability with commercially available MLV (magnetic low voltage) dimmers.

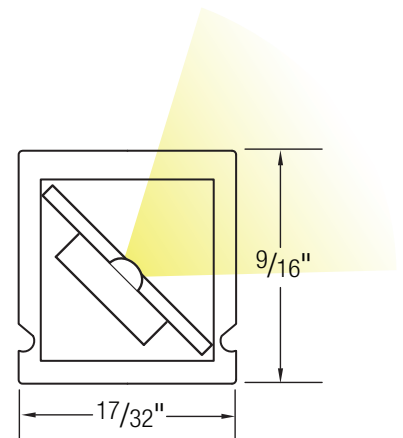

StageEdge™ Center & Extension Tube

Tube Type 017: Center Tube (Standard 7' length)

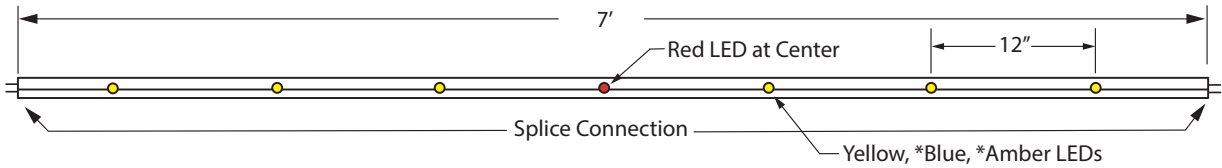

Tube Type 028/048/000/001: Extension Tube (Standard 8' length or custom length with 000 or 001)

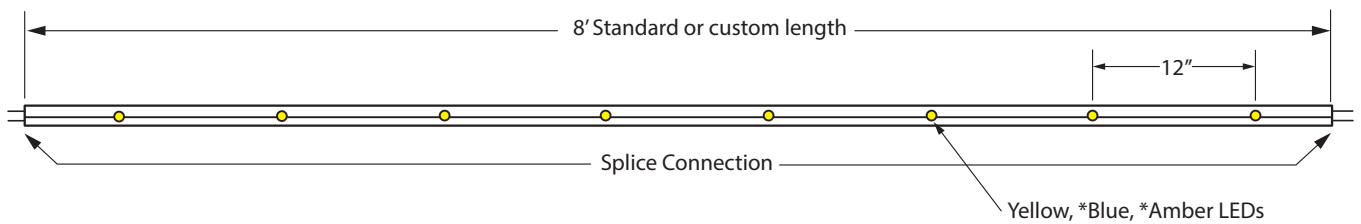

Lead Wire - Center & Extension Tube (Included)

1.5" Lead Wires are attached to both ends of the tube with 18AWG-22AWG butt connectors (see below)

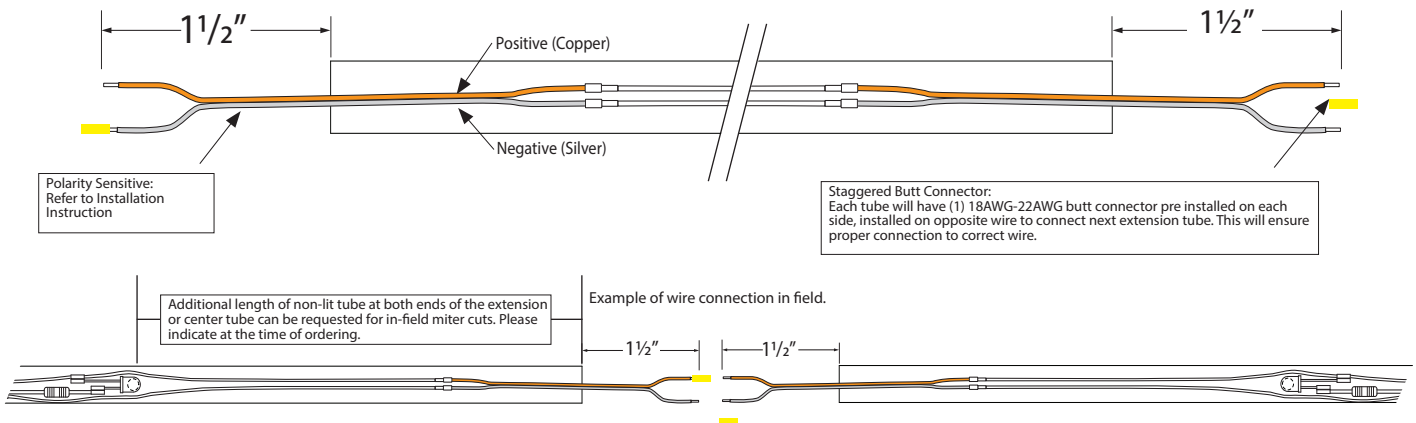

Ordering Information - Center & Extension Tube

PRODUCT CODE	LED SPACING	TUBE TYPE	VOLTAGE
STEG	12		12
STEG = StageEdge Angled Marker	12 = 12" OC	017 = 7' Center Tube (6 Yellow LEDs & 1 Red LED at center) 028 = 8' Extension Tube (8 Yellow LEDs) 037 = 7' Center Tube (6 Blue LEDs & 1 Red LED at center)* 048 = 8' Extension Tube (8 Blue LEDs)* 057 = 7' Center Tube (6 Amber LEDs & 1 Red LED at center)* 068 = 8' Extension Tube (8 Amber LEDs)* 000 = **Extension Tube (Yellow LEDs) 001 = **Extension Tube (Blue LEDs)* 002 = **Extension Tube (Amber LEDs)*	12 = 12V DC

*Consult factory lead time

**sold per/ft: indicate size needed at time of ordering

Tivoli, LLC. reserves the right to modify this specification without prior notice.

StageEdge™ Finish Tube

Tube Type 03: Finish Tube (Order per foot)
STEG-12-03C-12

Exact measurements are needed for both left and right Finish Tubes.
Please add to your order notes at time of order.
Finish Tubes are sold by the foot. (ex. 1'5" Ordered = 2' billed)

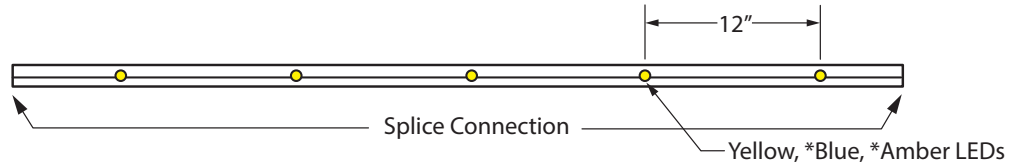

Lead Wire - Finish Tube (Included)

Finish Tube 03C: Two power feed options

Power Feed = NO
1.5" lead to connect to Extension Tube With Opposite side fitted with End Cap Finish.

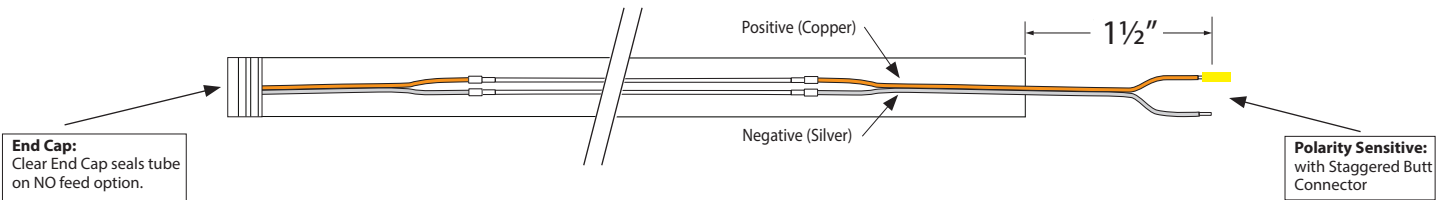

Power Feed = Yes
1.5" standard lead to connect to Extension Tube With Opposite side fitted with 72" length Power feed (included).

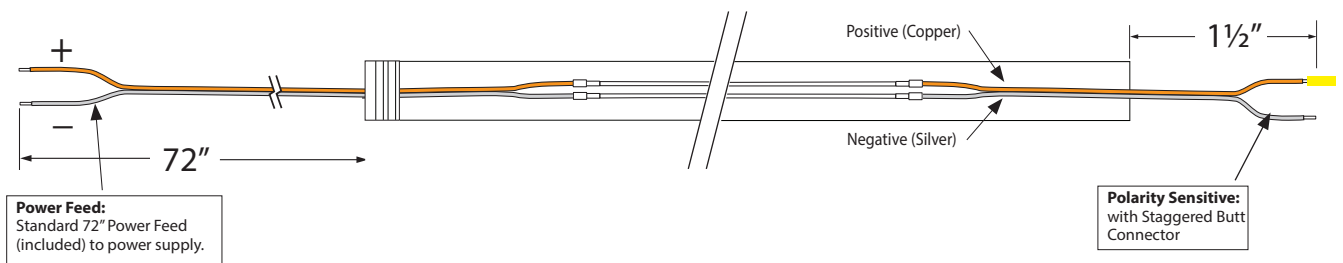

Ordering Information - Finish Tube

PRODUCT CODE	LED SPACING	TUBE TYPE	STAGE VIEW	POWER FEED	VOLTAGE
STEG	12				12
STEG = StageEdge Angled Marker	12 = 12" OC	03C = Yellow Finish Tube 04C = Blue Finish Tube* 05C = Amber Finish Tube*	L = Left Stage R = Right Stage	Y = Yes N = No	12 = 12V DC

*Consult factory lead time

Tivoli, LLC. reserves the right to modify this specification without prior notice.

Mounting Accessories

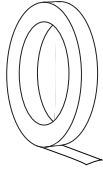

DBL-TP
Tubing double sided tape
¼"W X 180'



ADH-MB-75AM-10
Extrusion adhesive, 10.1 oz tubes, sold
individually, 30 per case.

Specification Data

Electrical Data	
Input Voltage	12V DC
Dimming Option	MLV/ELV/0-10V/DMX
Power Supply	Class 2
Power Consumption	0.22W per/LED

Physical	
LED Package	0.36mm Narrow-View LED
LED O.C.	12"
Viewing Angle	40°
Environment	Dry Location Only
Maximum Run Length	80' (80 LEDs per continuous run)
Radius Bend	20'

Performance	
Certification	ETL Listed
Warranty	5 Years



Recommended Power Supplies

ADUL - NON DIMMING

DESCRIPTION	CAT NO	APPLICATION	PRIMARY VOLTAGE	SECONDARY VOLTAGE	CIRCUIT BREAKERS	MAX LOAD	CIRCUIT CAPACITY
ADUL Series Class 2 Transformer	ADUL-80-1-5-12-D	Indoor / Damp	100-277V AC 50/60 HZ	12V DC	1	60W	5A
	ADUL-150-2-5-12-D				2	2x60W	2x5A
	ADUL-240-3-5-12-D				3	3x60W	3x5A
	ADUL-320-4-5-12-D				4	4x60W	4x5A

ADUL - 0-10V DIMMING

DESCRIPTION	CAT NO	APPLICATION	PRIMARY VOLTAGE	SECONDARY VOLTAGE	CIRCUIT BREAKERS	MAX LOAD	CIRCUIT CAPACITY
ADUL Series Class 2 Transformer	ADUL-80-1-5-12-DOT	Indoor / Damp	100-277V AC 50/60 HZ	12V DC	1	60W	5A
	ADUL-150-2-5-12-DOT				2	2x60W	2x5A
	ADUL-240-3-5-12-DOT				3	3x60W	3x5A
	ADUL-320-4-5-12-DOT				4	4x60W	4x5A

ADUL - DMX SINGLE ADDRESS

DESCRIPTION	CAT NO	APPLICATION	PRIMARY VOLTAGE	SECONDARY VOLTAGE	CIRCUIT BREAKERS	MAX LOAD	CIRCUIT CAPACITY
ADUL Series Class 2 Transformer	ADUL-80-1-5-12-DIN	Indoor / Damp	100-277V AC 50/60 HZ	12V DC	1	60W	5A
	ADUL-150-2-5-12-DIN				2	2x60W	2x5A
	ADUL-240-3-5-12-DIN				3	3x60W	3x5A

ADUL - DMX MULTI ADDRESS

DESCRIPTION	CAT NO	APPLICATION	PRIMARY VOLTAGE	SECONDARY VOLTAGE	CIRCUIT BREAKERS	MAX LOAD	CIRCUIT CAPACITY
ADUL Series Class 2 Transformer	ADUL-150-2-5-12-DIN-2	Indoor / Damp	100-277V AC 50/60 HZ	12V DC	2	2x60W	2x5A
	ADUL-240-3-5-12-DIN-3				3	3x60W	3x5A
	ADUL-320-4-5-12-DIN-4				4	4x60W	4x5A

INFINITY - MLV / ELV / 0-10V / PWM / TRIAC

DESCRIPTION	CAT NO	APPLICATION	PRIMARY VOLTAGE	SECONDARY VOLTAGE	CIRCUIT BREAKERS	MAX LOAD	MIN LOAD	CIRCUIT CAPACITY
Infinity Series Class 2 Transformer	INF-J-30-1-2.5-12	Indoor / Outdoor	100 - 277V AC	12V DC	1	30W	3W	2.5A
	INF-J-60-1-5-12				1	60W	6W	5A
	INF-J-180-3-5-12				3	3x60W	3x6W	3x5A
	INF-J-300-5-5-12				5	5x60W	5x6W	5x5A

Recommended Dimmers

DIMMING - 0-10V

DESCRIPTION	CAT NO	APPLICATION	INPUT VOLTAGE	OUTPUT VOLTAGE	MAX LOAD
0-10V Dimmer	DIM-LD-010	Indoor	12V/24V DC	12V/24V DC	30 mA max. output (sink only)

DIMMING - MLV

DESCRIPTION	CAT NO	APPLICATION	INPUT VOLTAGE	OUTPUT VOLTAGE	MAX LOAD
MLV Dimmer	N-600	Indoor	120V AC	120V AC	450W
	N-1000				800W
	N-1500				1200W
	D-600				450W
	M-600				450W
	M-1000				800W

DIMMING - ELV

DESCRIPTION	CAT NO	APPLICATION	INPUT VOLTAGE	OUTPUT VOLTAGE	MAX LOAD
ELV Dimmer	ME-600	Indoor	120V AC	120V AC	450W
	DE-300				300W

DMX IN-WALL CONTROLLER



Touchscreen

TVOQ-1-WH
White

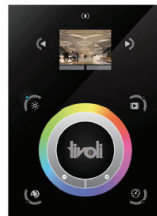

Touchscreen

TVOQ-10-XX-7
XX = BK (Black), WH (White)



Touchscreen

TVOQ-2-BK
Black